

March 9, 2018



Model 306™ User Manual

Document Revision 18-01



© 2012, 2014, 2017, 2018 OPEX® Corporation

All rights reserved. This publication is made available solely for use by the OPEX Service Organization. The information contained herein is proprietary, confidential and copyrighted by OPEX® Corporation. Copying, duplicating, selling, or otherwise distributing any part of this publication or the information contained herein without the express written consent of OPEX® Corporation is strictly forbidden.

Document History

Doc Rev	Date	Changes (click blue text to go to that page)
12-01	Sept. 2012	Initial Release. The Ovation Model 306 Manual was completely restructured for better viewing on a Tablet-style reader.
14-01	Nov. 2014	Increased supported languages, edited specifications, other minor edits
17-01	Nov. 15, 2017	Page 11 - Replaced machine keypad controls graphic to show international symbols that replaced text on newer machines.
18-01	March 9, 2018	Page 71 - Added FCC and Industry Canada information.

If you find errors, inaccuracies, or any other issues or concerns with this document, please contact the OPEX Technical Writers via email at:

GroupTechwriters@opex.com

Table of Contents

Document History	2
Introduction	5
Safety	6
Safety conventions used in this manual	6
Equipment safety precautions	7
Ergonomics	8
Overview of Model 306 Operation	9
Functional Description	10
Machine controls	11
Operating Instructions	13
The Run screen	13
Staging the mail	16
Preparing the mail	16
Setting the Envelope Height position	17
Setting the Thickness Detect position	17
Setting the Hi-Speed Inkjet Printer position	18
Operating the Model 306	19
Adjust LCD Contrast	22
Setting and Viewing Operator Passwords	22
Supervisor Operations	24
Job Menu	25
Add Job	26
Delete Job	27
Modify Job	27
SORT WIZARD	30
Copy Job	36
Sort List	37
Print All Jobs or Individual Job Parameters	37
Job Parameters	38
Operator Menu	45
System Configuration Menu	50
Audit Trail Menu	52

Password Options	57
Statistics	58
Operator Statistics	58
Supervisor Statistics	60
Troubleshooting	62
Routine Maintenance	65
Clean the Model 306	66
Replacing Report Printer Paper	68
Cleaning the Audit trail printer cartridge head	69
Specifications	70
FCC information / informations FCC	71
Industry Canada information / Industrie Canada l'information	71

Introduction

Omaton® Model 306™ & Model 306s™

High volume, high speed envelope opener with optional sorting capabilities

For more than thirty years, Omaton products have been a staple in mailrooms across the globe. The all-new Model 306 contains significant technological improvements over its predecessor, the Model 206 Envelopener, which has been the world's best selling envelope opening device for more than a decade.

The Omaton Model 306, with its ability to operate at a rated speed of up to 40,000 envelopes per hour, contains OPEX's latest mail opening technology and sets a new standard for high volume mail processing. The improved milling cutter with 8 cut-depth positions removes chips as small as 0.01" from the envelope edge, producing a soft, feathered edge while protecting valuable envelope contents. Even UPS and FedEx delivery envelopes are no match for the Model 306. Equipped with a new and robust operator control software interface, job setup can be done with ease and flexibility.

Most significantly, the Model 306 is also available with enhanced sorting capabilities as the Model 306s. Envelopes can be sorted to two locations based on programmable criteria such as thickness, length, and height. Optional batching capability allows items to be grouped together in pre-selected lot sizes.

Sorting options make the Model 306s a perfect fit for applications that require verification of contents either before or after extraction: like claims processing, remittance, and vote-by-mail. Because of its ability to differentiate between "clean mail" from "exception mail." The Model 306s also helps to ensure maximum productivity from mail extraction equipment by allowing operators to concentrate on extracting envelope contents from "clean" batches instead of trying to handle exceptions at the same time.

Safety

The information provided in this section is intended to educate the user on various safety issues regarding the Model 306.

Safety conventions used in this manual

OPEX documents use the following conventions to describe certain procedures and situations. Please be aware of these conventions when reading the manuals and operating the machine:



DANGER: Indicates a hazardous situation that, if not avoided, will result in death or severe injury. The use of this signal word is limited to the most extreme situations.



WARNING: Indicates a hazardous situation that, if not avoided, could result in death or serious injury.



CAUTION: Indicates a hazardous situation that, if not avoided, could result in minor or moderate injury.

NOTICE: Indicates information considered important, but not hazard related.

The following safety labels appear on the machine, and must be observed.

The label shown in Figure 1 is to warn the technician to turn off the AC power switch and disconnect the power cord before opening and servicing the Model 306. Servicing of the machine is to be performed by Authorized OPEX Technicians only. There are no user-serviceable parts within the machine.



Figure 1: Electrical warning label

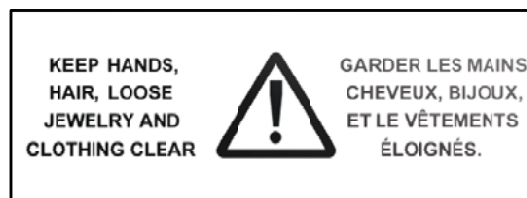

Figure 2: Feeder warning label

This label is to warn the user to keep loose objects away from any exposed, moving parts of the machine. The moving parts of the Model 306™ can become jammed and/or damaged by foreign objects. Keep hands, hair, loose clothing and jewelry away from the moving parts.

Equipment safety precautions



WARNING: Follow these additional safety precautions whenever installing, operating, servicing, or maintaining the equipment described in this manual.

- Do not attempt to clean the machine while it is running. A cloth (or similar material) should never be used to clean moving parts such as belts or rollers. The use of such material on moving mechanisms can result in damage to the machine or severe personal injury. If a belt, roller, gate or similar part needs to be cleaned, hand-crank the part during cleaning or clean it while stationary.

- Do not use flammable, high pressure, “canned air” to clean paper scraps and dust from the machine.
- Do not place fingers in the feed area while running the machine.
- Do not place fingers in the cutter area. The cutter blades are sharp and may cause cuts, should you inadvertently come in contact with them whether the machine is running or not.
- Do not set liquids on the Model 306 which could spill into the machine.



WARNING: Unplug the machine from the power source to remove power from the machine for servicing or when moving the machine.

Ergonomics

As in any occupation which requires you to perform the same motion repeatedly during the course of your work, it is important to consider how you perform your task. Always use proper operating procedures when working at your Model 306. Using improper procedures can result in a potentially serious injury.

To reduce possible risks, we strongly urge you to follow these suggestions:

- If you need to use a chair, maintain an upright body posture. Avoid the tendency to slump in your chair. The angle between your torso and thighs should always be 90 degrees.
- Occasionally change the angle of your posture for greater comfort.
- If possible, avoid operating the machine for longer than a single 8-hour shift.

While no suggestions can guarantee completely against work-related injuries, you will certainly increase your comfort and safety while operating the Model 306 if you put these suggestions into practice. The Model 306 has been designed with you in mind. If it is operated correctly, you should find your work experience comfortable and enjoyable.

Overview of Model 306 Operation

These steps provide a quick overview of the Model 306 Operation. For details on operating the Model 306, refer to “Operating Instructions” on page 13.

1. The operator loads mail onto the feed hopper. Normally, the operator can load a comfortable handful of mail directly from the Post office mail trays.
2. The operator starts the Model 306 by pressing the Start button.
3. The operator uses the keypad to login and select the correct operator. The operator may also have to enter a password.
4. The operator uses the keypad to select a job.
5. After selecting a job, the screen may prompt the operator to verify or adjust settings such as: cutter, printer, height detect and/or thickness detect positions.
6. The operator uses the keypad to select RUN, and presses the Enter button to begin operation.
7. Envelopes are fed from the feeder towards the retard stones.
8. The retard stones singulate the envelopes and sends them past the height and thickness measurement areas. The envelopes are measured by the sensors in this area (length, thickness, and/or height) and the envelope count is incremented.
9. The envelope moves through the milling cutter where the top side of envelope is cut (if the cutter is set to any position other than Position 0=no cut).
10. Envelope moves towards the sort gate.
11. If sorting is enabled, the sort gate directs the workflow to the correct path.

Functional Description

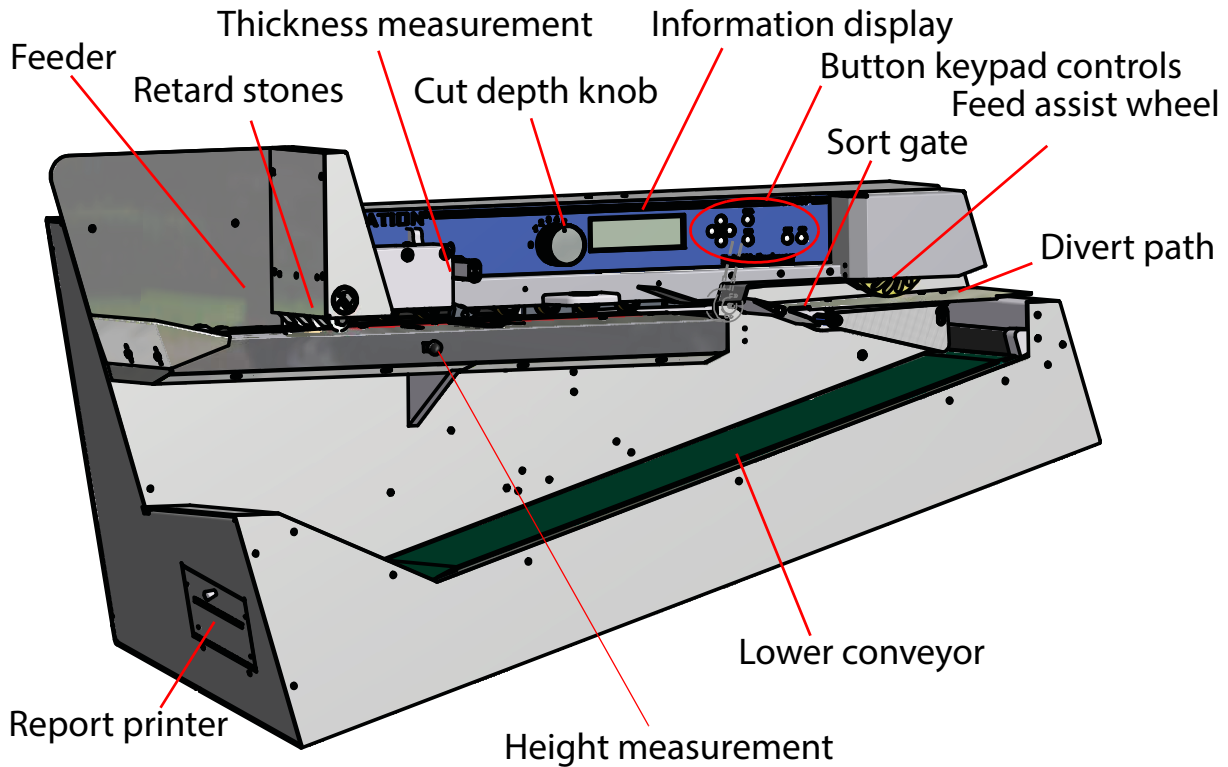

Feeder - Envelopes are loaded onto the feeder at the top left of the machine. This area is also often referred to as the hopper.

Retard stones - used to singulate and feed the stack of envelopes into the machine for subsequent processing.

Cut depth knob - used to set the depth of the cut - from 0.01" (0.03 cm) from the envelope edge (Position 1), up to 0.125" (0.32 cm) in depth (position 8). Cut Position 0 (no cut), can be used to sort envelopes without cutting them.

Information display - backlit LCD screen provides the user interface.

Button keypad controls - used to navigate the menus and start/stop the machine.

The sort gate, thickness measurement and height measurement areas of the machine are shown.

When sorting, the gate is used to divide the workflow into two paper paths. Path #1 is sent to the lower conveyor and path #2 is diverted towards a feed assist wheel where it is sent to an additional conveyor (not shown).

Report printer - located on the left side of the machine, provides a hard copy of job and operator statistical information.

Machine controls

The Model 306 controls are located on the keypad to the right of the operator as indicated in Figure 3.

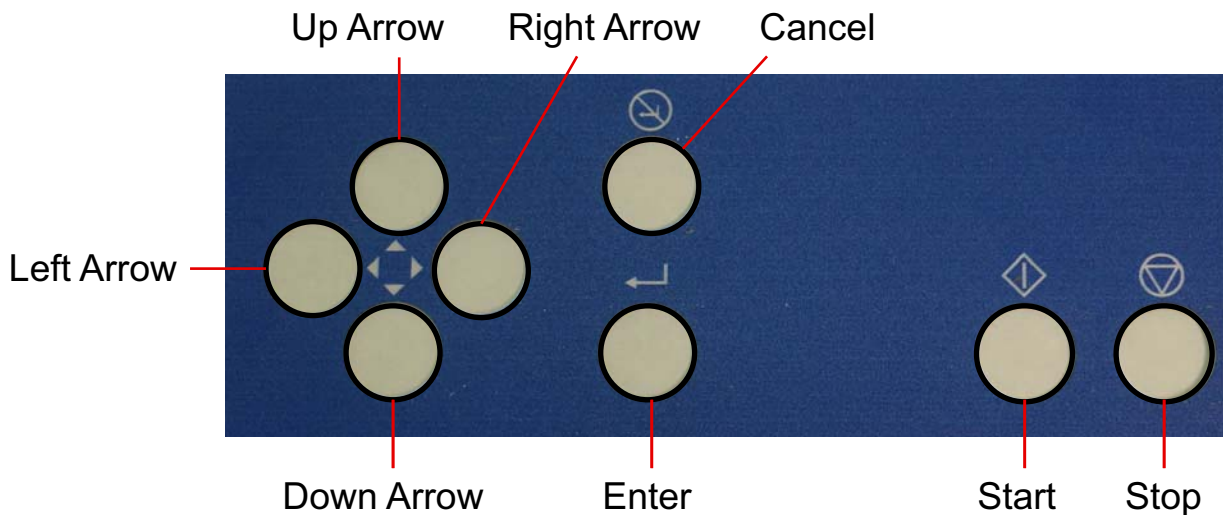

Figure 3: Model 306 keypad button names

Start button - used to turn on the Model 306.

Stop button - used to turn off the Model 306 display.

Enter button - used to make selections that are shown on the LCD display.

Cancel button - used to cancel actions (such as to stop a job run), or back out of a screen.

Arrow buttons - used to navigate through the data on the LCD screen.

Enhanced Scrolling

When a list or table has more information than can be displayed on the screen, a scroll bar will be displayed on the right side of the screen. The scroll bar gives you a relative idea where the cursor is in relation to the top and bottom of the list.

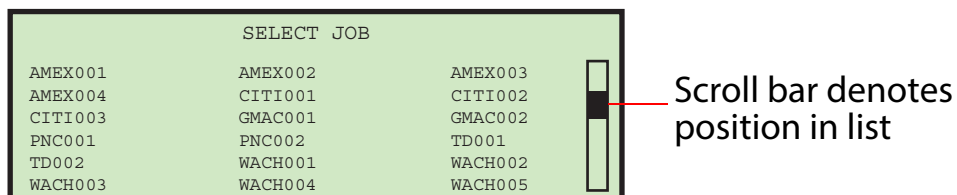

Figure 4: Typical enhanced scrolling screen

Keypad button functionality

Up Arrow Press - will allow you to navigate up through a column of data. When the upper item within the column is highlighted and you press the up key, the list of data is shifted down by a row and the previous line of data is displayed. If the up arrow is pressed while on the first row of data, then the cursor will move left to the first item in the table. If the first item is selected, then the cursor will move to the last item in the list.

Up Arrow Hold - Pressing and holding the up arrow will display the previous full page of data. The screen will wrap to the last page of data when you hold the up arrow while the first page of data is displayed. When the screen wraps to the last page, the last item in the list will be highlighted.

Down Arrow Press - will allow you to navigate down through a column of data. When the lower item within the column is highlighted and you press the down arrow, the list of data is shifted up by a row and the next line of data is displayed. If the down arrow is pressed while on the last row, the cursor will move left to the last item in the table. The screen will wrap to the first item in the list if you press the down arrow when the last item in the list is highlighted.

Down Arrow Hold - Pressing and holding the down arrow will display the next full page of data. The screen will wrap to the first full page of data when you hold the down arrow while the last page of data is displayed. The first item in the list will be selected when the screen wraps to the first page.

Left Arrow Press - will shift the highlighted selection one column to the left. If the selected item is in the first row and the left arrow is pressed, then the last item in the previous row will be selected. In addition, if the first item on the page is highlighted and the left arrow is pressed, the list is shifted down and the previous line of data is displayed. Pressing the left arrow while the first item on first page is highlighted will cause the screen to wrap to the last item in the list.

Left Arrow Hold - Left arrow hold will continuously shift the selection one item to the left until the key is released. It will work the same as the left arrow press.

Right Arrow Press - will shift the highlighted selection one column to the right. If the selected item is in the last row and the right arrow is pressed, then the first item in the next row will be selected. In addition, if the last item on the page is highlighted and the left arrow is pressed, the list is shifted up and the next line of data is displayed. Pressing the right arrow while the last item on the last page is highlighted will cause the screen to wrap to the first item in the list.

Right Arrow Hold - will continuously shift the selection one item to the right until the key is released. It will work the same as the right arrow press.

Operating Instructions

The Run screen

All of the basic Operator functions can be accessed right from the Run screen.

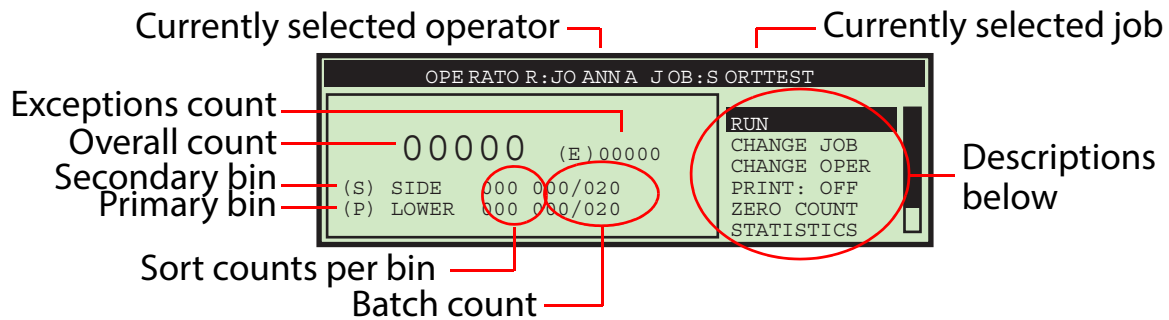

Figure 5: Run screen

Run screen information:

- The run screen will show overall counts.
- If batching is turned on, then batch count information will be shown.
- If the machine is a sort machine, then counts per bin will be shown.
- Exceptions will be shown on the run screen on machines that have the sort option or anytime a print job is being run.
- If sorting is turned on, then an indicator will appear telling the operator which bin is the primary and which is the secondary.

RUN

This selection will turn the motor on to process mail using the currently selected job and operator.

CHANGE JOB

This selection will allow the operator to change the currently selected job. This selection will not appear if there is only one job set up on the machine.

CHANGE OPER

This selection will allow another operator or the supervisor to be selected. Provisions are made to password-protect the use of the supervisor functions. Operators can also be optionally protected by password.

PRINT

In jobs that have printing enabled, this selection will be shown. This will allow the operator to temporarily turn audit trail printing on and off. This capability was provided in case there is an issue with the printer and the operator wants to run mail without correcting that issue.

In jobs that have printing enabled, this selection will also provide the operator with the ability to clean the heads of the print cartridge. For more information, see “Cleaning the Audit trail printer cartridge head” on page 69.

ZERO COUNT

This will allow the user to reset the statistics counters for the current run. At the beginning of a run or at any point during a run, a user may reset the counters. This will cause the software to zero all of the counts on the screen, close out the current statistics “record,” and open up a new one.

STATISTICS

This will show the DISPLAY STATISTICS screen, which will allow the user to display and optionally print their statistics on the reports printer, if purchased.

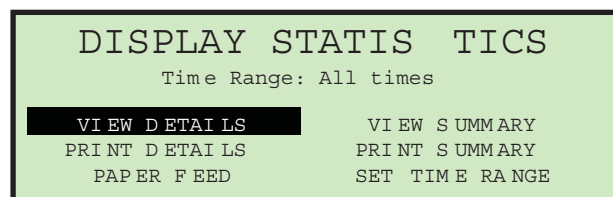

Figure 6: Display Statistics screen

The operator can only view runs that were saved under their name. The choices are:

- **VIEW DETAILS** - Pulls together all jobs run by this operator in the specified time range in their each individual view (example: if the operator ran 4 jobs, the data will be pulled together into 4 views).
- **VIEW SUMMARY** - Pulls together all jobs run by this operator within the specified time range in one view.
- **PRINT DETAILS** - provides a printout of the details described above. User must have purchased the optional stats printer.
- **PRINT SUMMARY** - provides a printout of the summary described above. User must have purchased the optional stats printer.
- **SET TIME RANGE** - allows operator to set specified date and time for pulling the above information together.

More details of statistics can be found in the Statistics section of the Supervisor Functions (“Supervisor Statistics” on page 60).

MY PASSWORD

This will allow an Operator to change their password. See “Setting and Viewing Operator Passwords” on page 22 for more information.

Staging the mail



Figure 7: Model 306 with mail tray supports

The convenient mail tray supports may be used to hold U.S. Postal Service mail trays. The integrated mail tray supports can be opened or closed depending on your needs.

Preparing the mail

Very little preparation of the mail is required. Handfuls of mail can quickly be loaded into the feed area. A simple tap to align the top or leading edge may be necessary when loading mixed mail. Envelopes of different sizes and thicknesses can be run at the same time.

Setting the Envelope Height position

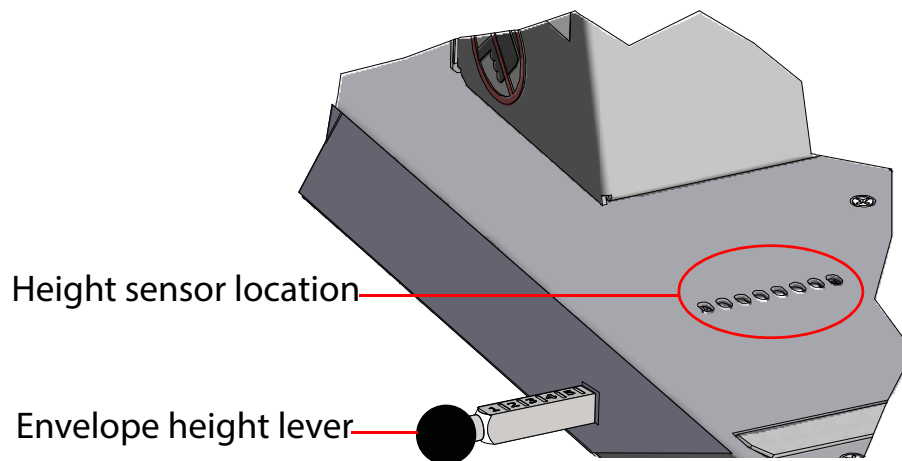

Figure 8: Envelope height adjustment

The envelope height lever is used to set the position of the envelope height sensor. When starting a job, you may see a screen telling you to verify or adjust the height adjustment to a specific numbered position. Slide the lever in/out to set the correct position. Use the numbered marks on the lever to set this position (refer to Figure 8).

Setting the Thickness Detect position

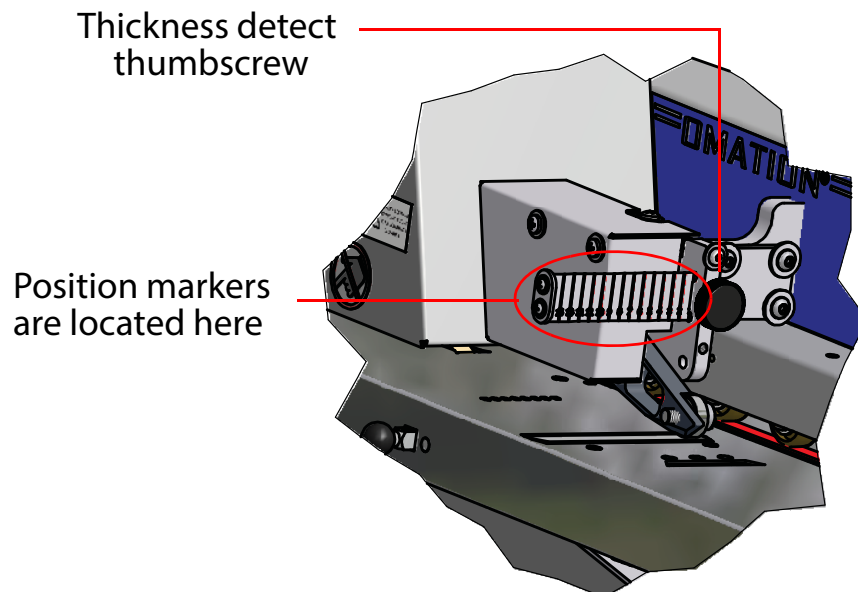

Figure 9: Thickness Detect adjustment

When starting a job, you may see a screen telling you to verify or adjust the Thickness Detect to a specific numbered position. To make adjustments to the thickness detector, loosen the thumb screw (as shown in Figure 9), move the thickness detector in or out to the correct position, and tighten the thumbscrew.

Setting the Hi-Speed Inkjet Printer position

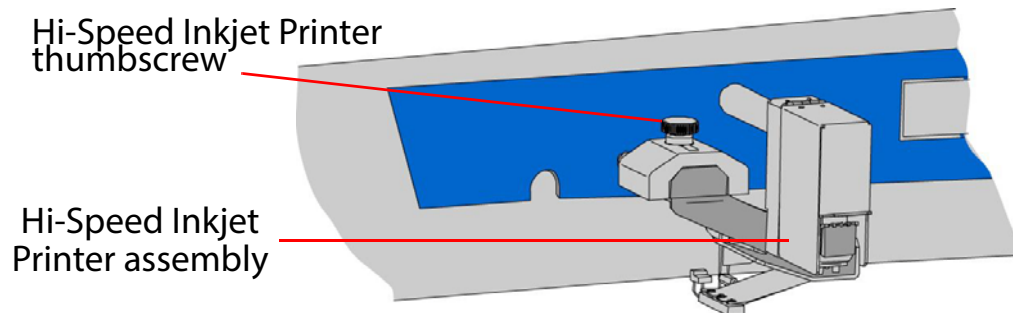

Figure 10: Hi-Speed Inkjet Printer adjustment

When starting a job, you may see a screen telling you to verify or adjust the Hi-Speed Inkjet Printer to a specific numbered position. To make adjustments to the printer position, loosen the thumb screw as shown in Figure 10. Then move the inkjet printer assembly in or out to the desired position, and tighten the thumbscrew.

Operating the Model 306

1. Make sure that the machine is plugged into an outlet.
2. Start the Model 306. If the information display is off, press the Start button. If passwords are enabled, the login screen will be displayed.

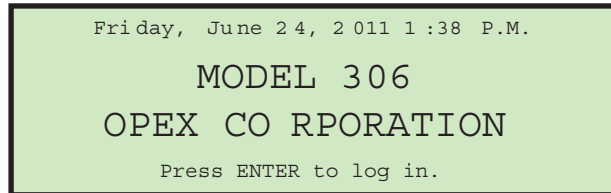

Figure 11: Login screen

If passwords are disabled, the run screen appears as shown in step 6..

3. Press the Enter button. The SELECT OPERATOR screen appears.

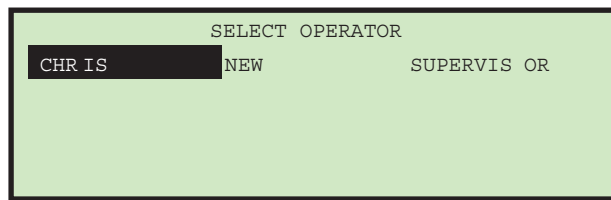

Figure 12: Select Operator screen

4. Use the Arrow keys to highlight an operator and press the Enter button to select the operator. If a password is required for the selected operator, the ENTER PASSWORD screen will be displayed next (see Figure 13). If a password is not required, skip to step 6..

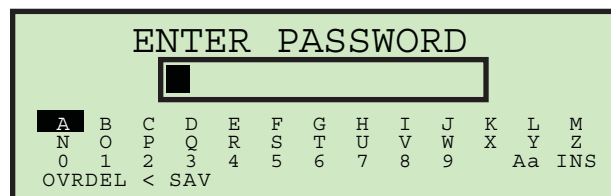

Figure 13: Enter Password screen

5. Use the Arrow keys and the Enter button to enter a password. An asterisk (*) will be displayed in the password field for each character entered. Entering SAV will force the software to check to see if the entered password

matches the saved password. If the correct password was entered, it is valid until the Stop button is pressed (LCD off).

If you entered an incorrect password, the INCORRECT PASSWORD warning message is displayed.

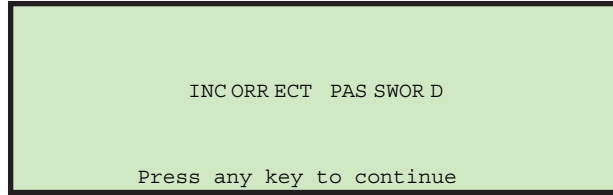

Figure 14: Incorrect Password screen

Pressing any button on the keypad will return you to the run screen.

6. If the password was entered correctly, or if passwords are disabled, the Run screen is displayed with the newly-selected Operator.

Selected operator name appears here

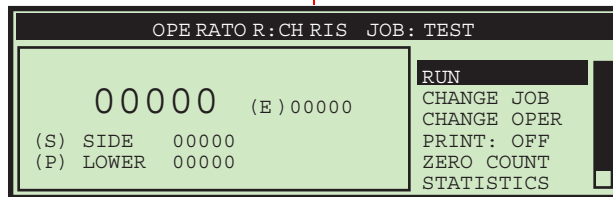

Figure 15: Operator Main Menu screen (example)

7. Press the Up/Down arrow buttons to go to CHANGE JOB and press the Enter button. The Select Job screen appears (Figure 16).

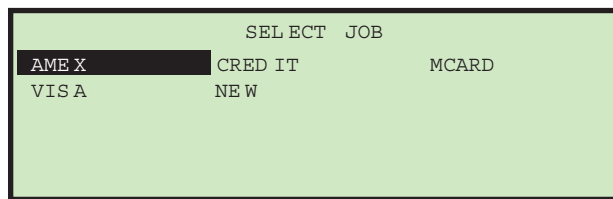

Figure 16: Select Job screen

8. Use the Arrow buttons to choose a job, and press Enter to select it. The Run screen is displayed - with the newly-selected job.

9. On the Run screen, use the Arrow buttons to navigate to RUN, and press Enter. Based on the job settings, you may have additional information that appears on the screen, such as the following example:

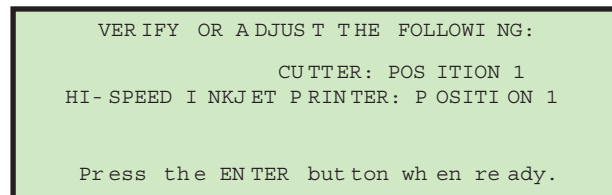

Figure 17: verification screen

10. Verify the adjustments needed for the selected job, and press Enter to start.

Note: While running the machine, you should watch trash levels and chip “haystacking” to prevent backups that might jam the cutters and create a service call.

Stopping the machine

1. Press the Cancel button to stop the job and return to the Run screen. The Model 306 will stop running the selected job. From time to time, the machine may stop for jam control. If the machine stops, an error message will appear on the run screen. Simply clear the visible jam and press Enter to restart the machine. Refer to Table 5 on page 62 for a list of error messages.

Adjust LCD Contrast

The contrast level for the LCD display can be adjusted for optimal viewing.

1. Press the Stop button on the keypad so that the LCD is in the off state.
2. Press the Left arrow button. The Adjust Intensity screen appears (Figure 18).

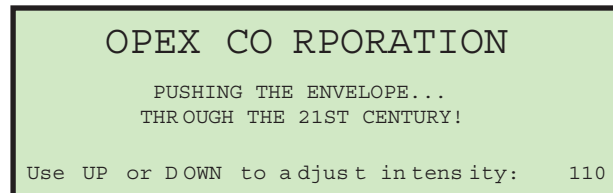

Figure 18: Adjust Intensity screen

3. Use the Up or Down buttons to darken or lighten the display as desired. A numerical value in the lower right corner of the display will indicate the display setting. The value can range from 0 (lightest) to 255 (darkest).
4. Once the contrast level is set for optimal viewing, press Cancel to exit the Adjust Intensity screen. Either the login screen is then displayed (if passwords are enabled), or the run screen is displayed (if passwords are disabled).

Note: If you should power up the Model 306 and the display does not appear to have text, or if it looks solid black, it may simply be that the intensity has been accidentally set to either of its extreme positions. Try performing this adjustment first before contacting Opex Tech Support for assistance.

Setting and Viewing Operator Passwords

The operator has the ability to set and reset their password. However, the operator will need to enter his/her current password before the password can be reset. If a password has not been previously entered, the user will not be prompted to enter their current password before entering a new password. The supervisor also has the ability to enable/disable operator passwords.

To change a password

1. After logging in, use the Arrow buttons to select MY PASSWORD from the Run screen to change the currently selected operator's password.

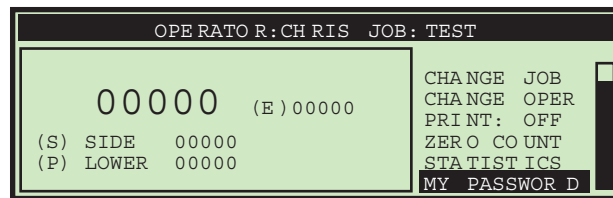

Figure 19: Run screen - select MY PASSWORD

2. Press Enter. The CHECK PASSWORD screen (Figure 20) will be displayed to remind the operator that leaving the password blank will disable the password feature.

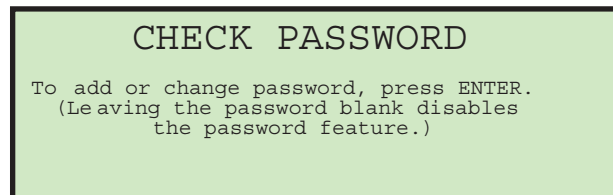

Figure 20: Check Password screen

3. Press Enter to display the CURRENT PASSWORD screen (Figure 21).

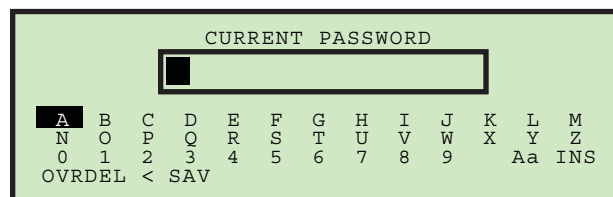

Figure 21: Current Password screen

4. The operator must enter their current password before setting their new password. Use the keypad to enter the current password.

Once the correct current password has been entered, the display automatically changes to the NEW PASSWORD screen (Figure 22), allowing you to create a new password.

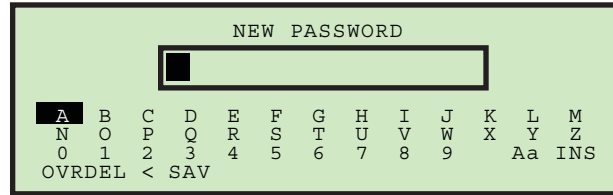

Figure 22: Enter Password screen

5. Enter the new password using the keypad. The password can be up to 10 characters in length. Selecting SAV will save the new password. The LCD will return to the run screen after entering a password.

Supervisor Operations

The supervisor role is to manage Operators and Jobs. All of the supervisor tasks can be launched from the supervisor main menu.

To access the Supervisor screen

1. If the machine is off, press the Start button. The Login screen appears.

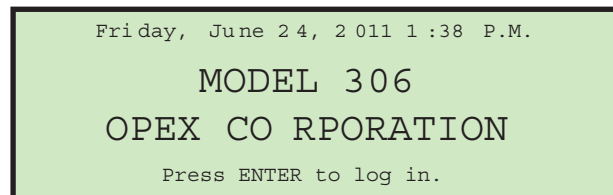

Figure 23: Login screen

2. Press Enter. The SELECT OPERATOR screen appears.

3. Use the arrow keys to select SUPERVISOR, and press Enter. The Supervisor screen will be displayed.

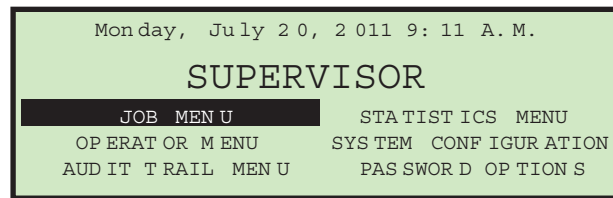

Figure 24: Supervisor screen

This screen is where all the supervisor tasks can be launched. The following tasks can be performed:

- JOB MENU - add, modify and print jobs. Described on page 25.
- STATISTICS MENU - view and print statistical reports. Described on page 60.
- OPERATOR MENU - add, modify and print operators. Described on page 45.
- SYSTEM CONFIGURATION - view and update the system configuration parameters. Details of these parameters are located on page 50.
- AUDIT TRAIL MENU - view and update the audit trail parameters. Described on page 52.
- PASSWORD OPTIONS - globally enable or disable all passwords. Described on page 57.

Job Menu

A Supervisor has the ability to create and maintain a job list. A maximum of 100 jobs are supported. Selecting JOB MENU and pressing Enter will display the Job Menu screen, and allow the supervisor to perform the following functions:

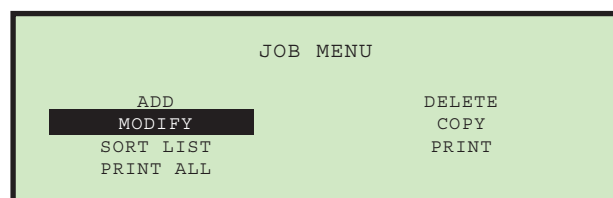

Figure 25: Job menu screen

- ADD – enter a new job and setup the job options.

- DELETE - select a job from the job list and delete the job.
- MODIFY – select an existing job from the job list and modify the job’s options.
- COPY - select an existing job from the job list and make a new job based on the existing job parameters. Parameters for the new (copied) job can also be edited.
- SORT LIST – alphabetically sort the job list.
- PRINT – select a job from the job list and print all parameters associated with the selected job (available when stats printer option is purchased).
- PRINT ALL - print the entire list of jobs (available when stats printer option is purchased).

Add Job

The supervisor has the ability to create a new job.

1. On the Job Menu screen (Figure 25), select ADD, and press Enter. The RENAME JOB screen appears as shown in Figure 26.

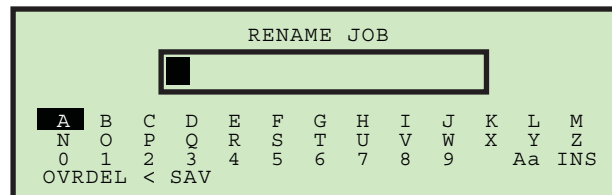

Figure 26: Rename Job screen

2. Enter the new job name using the Arrow buttons to navigate through the onscreen keypad. Selecting SAV will create the new job. Pushing the Cancel button on the keypad will end the job creation process.

Once you have named the job and selected SAV, the following screen appears as shown in Figure 27.

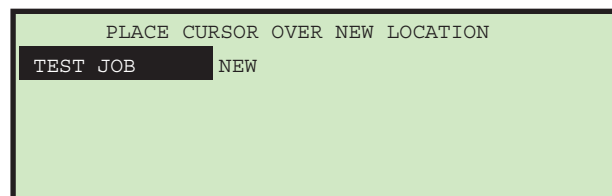

Figure 27: Place Cursor Over New Location (job) screen

3. Place the cursor over an existing job and press Enter to place the job in the list. The new job will be placed after the selected job, and the JOB SETUP screen appears.

For details on the Job Setup screen, see “Modify Job” on page 27.

Delete Job

The supervisor can select a job from the job list and delete it.

1. On the Job Menu screen (Figure 25), select DELETE. The SELECT JOB TO DELETE screen appears as shown.

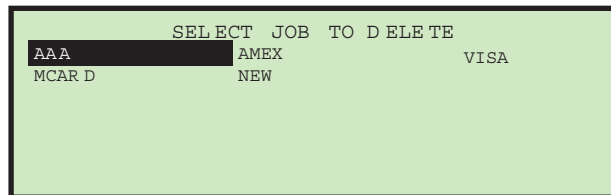

Figure 28: Select Job to Delete screen

2. Use the Arrow keys to choose a job, and press Enter to delete the job. The job will be deleted, and the display will return to the JOB MENU screen.

Modify Job

The MODIFY job selection allows the supervisor to edit an existing job.

1. On the Job Menu screen (Figure 25), select MODIFY. The SELECT JOB TO MODIFY screen appears.

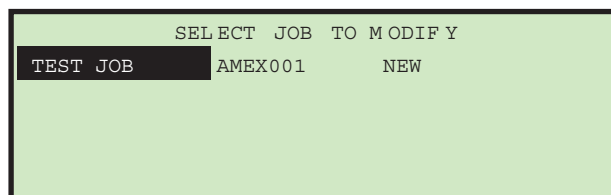

Figure 29: Select Job to Modify screen

2. Use the Arrow keys to choose a job, and press Enter to select the job. The job will be deleted, and the display will return to the JOB MENU screen. The JOB SETUP screen will be displayed (Figure 30).

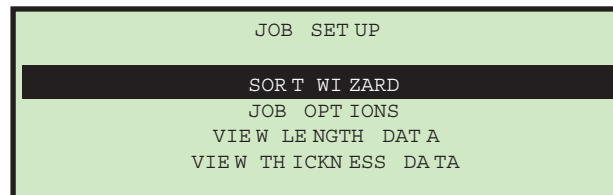

Figure 30: Job Setup screen

The job setup options are described below.

Sort Wizard

This selection should be used when creating a job that involves sorting by thickness, or by length. The sort wizard will set various machine parameters for the user based upon answers to questions and data that is collected when mail is run. The sort wizard can also be used to set height parameters.

The user should have an idea how they would like to sort their mail into two piles using any combination of length, height or thickness. The user must also have a good selection of primary mail that will be representative of the full range (that is, it contains some of the thinnest and thickest mail that they would like to go into the primary pile). For more information on the Sort Wizard see, “SORT WIZARD” on page 30.

Job Options

This selection will allow the supervisor to modify any existing jobs. Parameters will be shown on a screen in the order shown in “Model 306 Job Parameters” on page 39. Most parameters can be set based on expected results, such as printing or no printing, for example. The length data and thickness readings are obtained by running the job with the length and/or thickness parameters wide open, and then viewing the data using the provided screens detailed below.

View Length Data

Selecting this option displays the LENGTH HISTOGRAM screen.

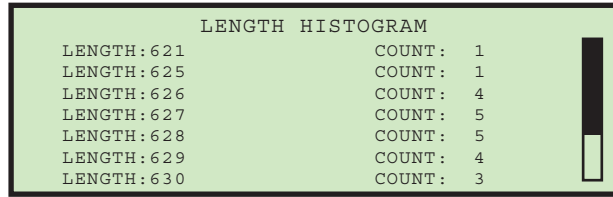

Figure 31: Length Histogram screen

This screen shows the length measurements. The data is stored in a buffer of 599 counters representing 400-999. When a piece is run, the software will update the appropriate counter (i.e., a length of 700 will increment the 300th counter). The display software will show the first 50 non-zero counters. Once a counter reaches 255, it will stop incrementing.

View Thickness Data

Selecting this option displays the THICKNESS HISTORY screen.

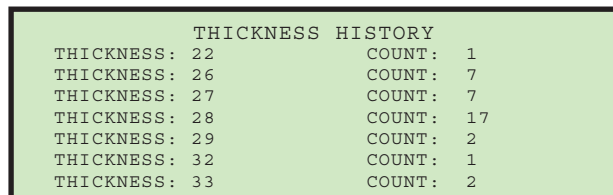

Figure 32: Thickness History screen

This screen displays the output of the average thickness algorithm. The data is stored in a buffer of 256 byte counters representing calculations of 0 to 255. When a piece is run, the software will update the appropriate counter (i.e., an average thickness of 32 will increment the 32nd counter). The display software will show the first 50 non-zero counters. Once a counter reaches 255, it will stop incrementing.

SORT WIZARD

The Sort Wizard is used to configure a sorting job.

NOTICE: When running, the Sort Wizard will modify the job to perform its functions. If the user presses the Stop button or power is lost during a sort wizard setup, the job will not be properly restored to its original state.

1. From the Supervisor > Job Setup screen (Figure 30), select SORT WIZARD, and press Enter. The sort wizard will start out by asking three questions that must be answered. The first asks if you want to sort on thickness as shown below.

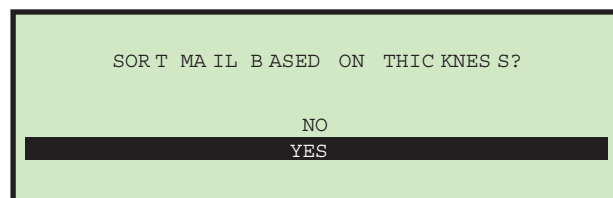

Figure 33: Sort Mail Based On Thickness screen

2. Use the Arrow buttons to select either NO or YES, and press Enter. The second question asks if you want to sort on length as shown below.

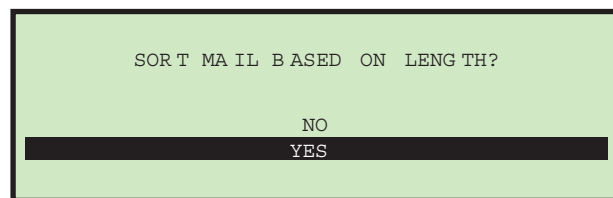

Figure 34: Sort Mail Based On Length screen

3. Use the Arrow buttons to select either NO or YES, and press Enter. The third question asks if you want to sort on height as shown below.

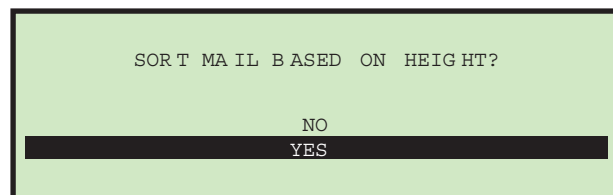

Figure 35: Sort Mail Based On Height screen

4. Use the Arrow buttons to select either NO or YES, and press Enter.

Note: If the user answers NO to all of the above, the job will be set accordingly and the message SORT WIZARD COMPLETED will be displayed. This job will obviously not be set to sort mail.

5. If one or more of the above was answered YES, then the wizard asks where you would like the primary mail sorted to.

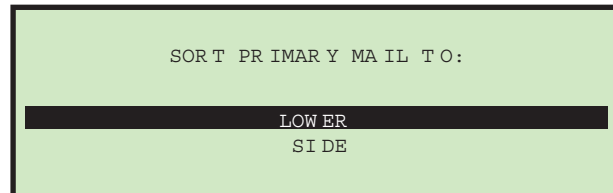

Figure 36: Sort Primary Mail To screen

6. This screen is used to select the area where the primary mail will be sent. Use the Arrow buttons to select either LOWER or SIDE, and press Enter.
7. If sorting on thickness, the wizard will ask the following question regarding thickness values.

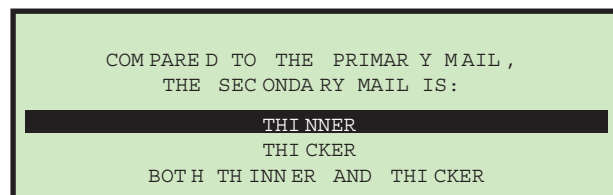

Figure 37: Compared To Primary Mail, The Secondary Mail Is (thickness) screen

8. Use the Arrow buttons to make a selection, and press Enter. Choices are: THINNER, THICKER or BOTH THINNER AND THICKER.

This question is being asked to help the wizard set the minimum and maximum thickness values. If THINNER is selected, then the maximum will be set to the highest valid setting and minimum will be set after the sample set of primary mail is run. If THICKER is selected, then the minimum will be set to the lowest valid setting and maximum will be set after the sample set of primary mail is run. If both are selected, then minimum and maximum will be set after sample set is run.

9. If sorting on length, the wizard will ask the following question regarding length values.

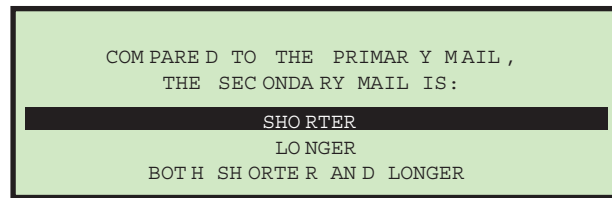

Figure 38: Compared To Primary Mail, The Secondary Mail Is (length) screen

10. Use the Arrow buttons to make a selection, and press Enter. Choices are: SHORTER, LONGER or BOTH SHORTER AND LONGER.

This question is being asked to help the wizard set the minimum and maximum length values. If SHORTER is selected, then the maximum will be set to the highest valid setting and minimum will be set after the sample set of primary mail is run. If LONGER is selected, then the minimum will be set to the lowest valid setting and maximum will be set after the sample set of primary mail is run. If both are selected, then minimum and maximum will be set after sample set is run.

11. If sorting on height, the wizard will ask how the height sensor will respond when it is blocked by an envelope.

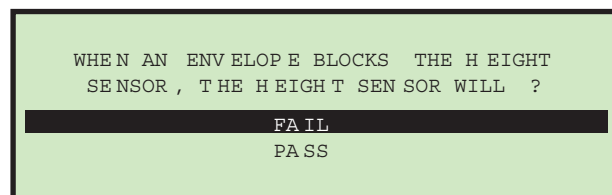

Figure 39: When An Envelope Blocks The Height Sensor, The Height Sensor Will screen

12. Use the Arrow buttons to make a selection, and press Enter. Choices are: FAIL or PASS. This question is being asked to help set the WHEN HEIGHT BLOCKED job parameter. For more details, see “SORT ON HEIGHT” on page 41.

13. Once these questions are answered, the following informational screen appears:

```
PLACE REPRESENTATIVE SAMPLE OF
PRIMARY MAIL IN FEEDER TO CATEGORIZE.
SAMPLE SHOULD INCLUDE MAIL THAT
IS CONSIDERED PROPER HEIGHT, LENGTH
AND THICKNESS. ADJUST TMD OR HEIGHT
DETECT SENSOR TO ENSURE OPEREA DINGS.
PLACE CUTTER IN NO-CUT POSITION.
PRESS ENTER TO CONTINUE.
```

Figure 40: Sort Wizard information screen

14. Once the tasks on the screen have been accomplished, press Enter. The Sort Wizard run screen appears.

```
SORT WIZARD JOB:TEST
0032          MIN  MAX
THICKNESS: 023 022 032
LENGTH: 625 624 634
HEIGHT: *
RUN
CLEAR
CONTINUE
CANCEL
PROFILES
```

Figure 41: Sort Wizard run screen

15. Here the user can run their primary mail, which will provide the Sort Wizard with information to set the parameters in the job. This screen will:

- Show counter of mail run.
- Appropriately show thickness information including thickness reading of last piece, minimum reading and maximum reading.
- Appropriately show length measurement information including length measurement of last piece, minimum reading and maximum reading.
- Appropriately show height indicator, which can be either PASS or FAIL.
- Provide the user with the ability to RUN, CLEAR, CONTINUE and CANCEL.

RUN - will allow the user to run mail for the purpose of collecting job parameter information.

CLEAR - provides the user with the ability to clear all of the collected data, essentially starting over. This can be used if secondary mail was accidentally run or the user noticed double feeds were occurring.

CONTINUE - will take the user to the next screen of the sort wizard.

CANCEL - will take the user back to the screen they were at when they started the sort wizard.

- When running mail, all jam control software will be activated as if it were a regular run. The exception is double feed detection will not be active.
- All mail will be sent to the primary destination.
- User is responsible for ensuring mail does not double feed, as double detect requires valid length and/or thickness maximums to be properly set.
- The sort wizard does not provide the ability to set all job parameters. The user will still need to set all parameters which are not related to thickness, length and/or height.
- If thickness sorting is turned on, the thickness parameters are set based on the answer to the following Sort Wizard question:

Table 1: COMPARED TO PRIMARY MAIL, THE SECONDARY MAIL IS:

If set to:	Then:
THINNER	Thickness minimum is set to the minimum collected value, maximum is set to the highest valid setting.
THICKER	Thickness minimum is set to the lowest valid setting, maximum is set to the highest collected value.
BOTH THINNER AND THICKER	Thickness minimum is set to the lowest collected value, maximum is set to the highest collected value.

- If length sorting is turned on, the length parameters are set based on the answer to the following Sort Wizard question:

Table 2: COMPARED TO PRIMARY MAIL, THE SECONDARY MAIL IS:

If set to:	Then:
SHORTER	Length minimum is set to the minimum collected value, maximum is set to the highest valid setting.
LONGER	Length minimum is set to lowest valid setting, maximum is set to the highest collected value.
BOTH SHORTER AND LONGER	Length minimum set to lowest collected value, maximum is set to the highest collected value.

PROFILES - selecting this option will display a graph of each piece run.

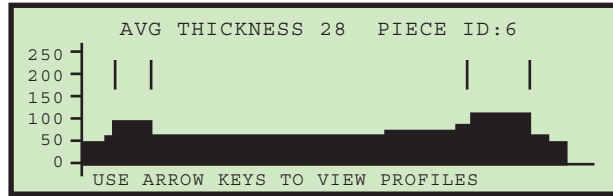

Figure 42: Thickness Profiles screen

Press the arrow keys to view the thickness profile for each of the pieces run in the Sort Wizard test. Press Cancel to return to the Sort Wizard run screen.

THICK. DATA - Selecting this option displays the THICKNESS HISTORY screen, as described in "View Thickness Data" on page 29.

LENGTH DATA - Selecting this option displays the LENGTH HISTOGRAM screen, as described in "View Length Data" on page 29.

16. Selecting CONTINUE and pressing Enter will display the following screen asking if you would like to test the sort scheme.

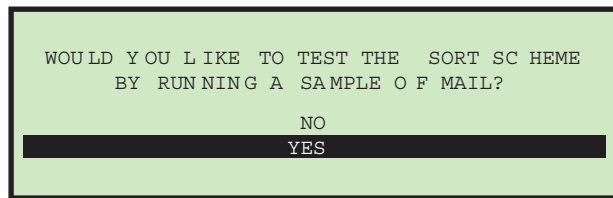

Figure 43: Confirmation run screen

17. If you select YES, an informational screen is displayed (Figure 44).

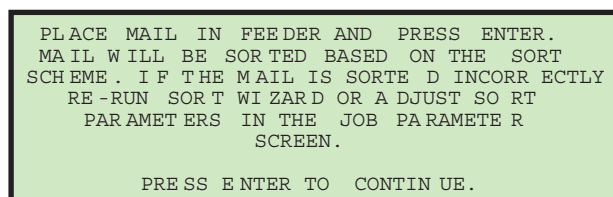

Figure 44: Informational screen

18. Press Enter to complete the confirmation run. Make any adjustments to the job parameters as needed.

Copy Job

This option allows you to select an existing job from the job list and make a new job based on the existing job parameters. Parameters for the new (copied) job can also be edited.

1. On the Job Menu screen (Figure 25), select COPY, and press Enter. The SELECT JOB TO COPY screen appears (Figure 45).

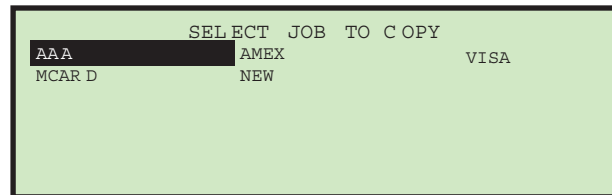

Figure 45: Select Job To Copy screen

2. Use the Arrow buttons to select an existing job, and press Enter. The RENAME JOB screen appears (Figure 46).

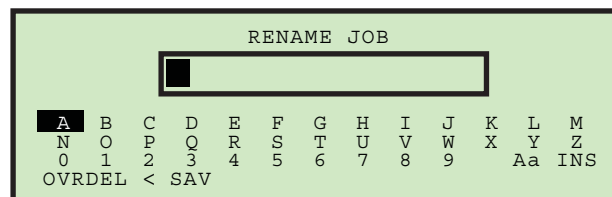

Figure 46: Rename Job screen

3. Enter the new job name using the Arrow buttons to navigate through the onscreen keypad. Selecting SAV will create the new job. Pushing the Cancel button on the keypad will end the job creation process.

Once you have named the job and selected SAV, the following screen appears.

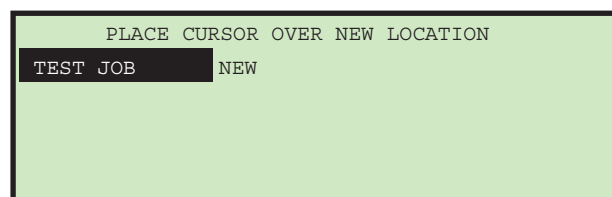
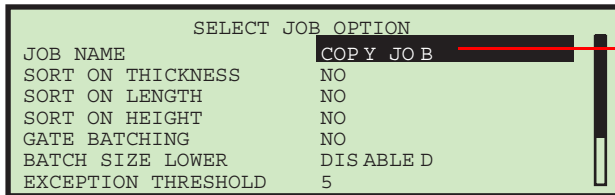

Figure 47: Place Cursor Over New Location (job) screen

- Place the cursor over an existing job and press Enter to place the job in the list. The new job will be placed after the selected job, and the SELECT JOB OPTION screen appears.



New Job Name

Parameter settings are copied from the existing job, but they are separate from the existing job, and can be edited for the new job.

Figure 48: Select Job Option screen

- Use the Up/Down arrows to highlight a job parameter, and press Enter to select it. The available job parameters are described on page 38.

Sort List

- On the Job Menu screen (Figure 49), select SORT LIST.
- Selecting SORT LIST will alphabetically sort the job list.

Print All Jobs or Individual Job Parameters

Job Information can be printed out for a single job or all jobs (available with stats report printer option). The printout includes the job name and all job parameters (see Figure 50). The user must be logged in as a supervisor to printout the report. The print choices are available on the Job Menu screen.

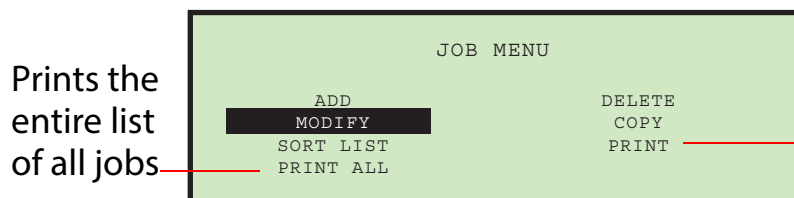

Prints the entire list of all jobs

Selects an individual job, and prints all parameters associated with it

Figure 49: Job Menu screen

Note: If you want to print information for a specific job, you will be presented with an additional screen where you can choose the job.

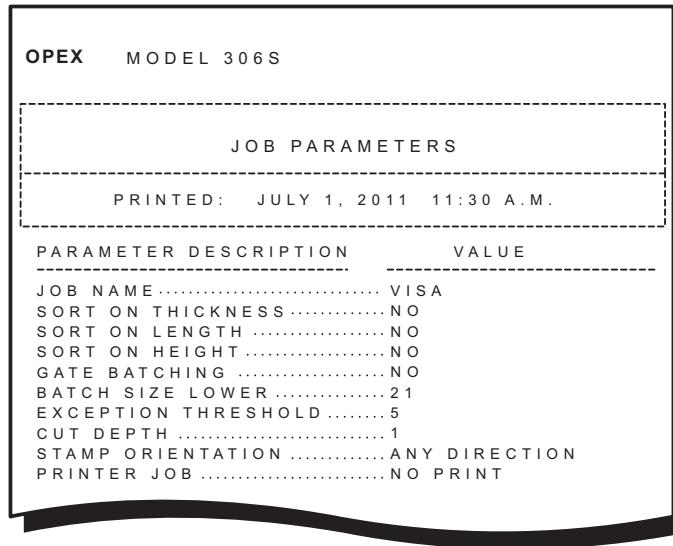

Figure 50: Example printout of Job information

Job Parameters

This section describes the job parameters that can be set for each job. The visibility of certain job parameters are turned on/off to help the user. Job parameters can be accessed when adding a new job, as described in “Add Job” on page 26, as well as when modifying an existing job (described below).

To edit job parameters for an existing job

1. Login as a Supervisor.
2. On the SUPERVISOR screen (see Figure 24), use the arrows to select JOB MENU and press Enter. The Job Menu screen appears (Figure 51).

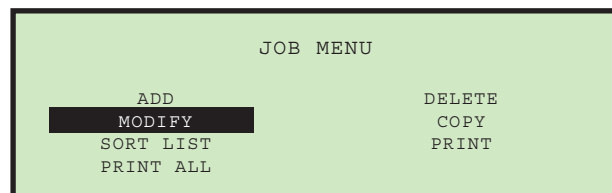

Figure 51: Job Menu screen

3. Select MODIFY, and press Enter. The SELECT JOB TO MODIFY screen appears.

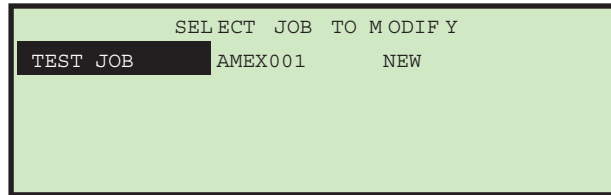

Figure 52: Select Job To Modify screen

4. Use the Arrow keys to choose a job, and press Enter to select the job. Once you've selected a job, the JOB SETUP screen appears.

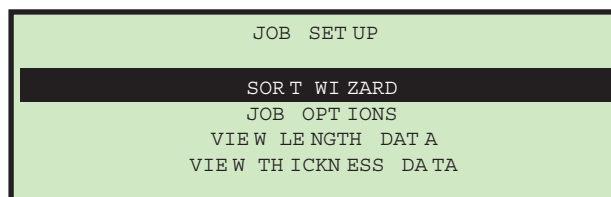
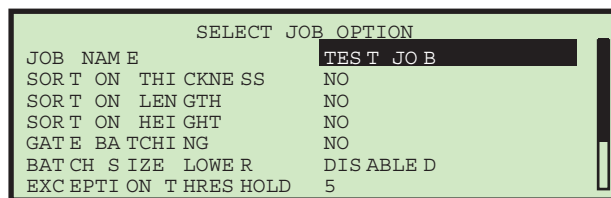

Figure 53: Job Setup screen

5. On the JOB SETUP screen, select JOB OPTIONS, and press Enter. The SELECT JOB OPTION screen appears.



6. Use the Up/Down arrows to highlight a job parameter, and press Enter to select it. The available job parameters are described below.

Table 3: Model 306 Job Parameters

Parameter	Description
JOB NAME	10 character text field. Once a job has been created, you can use this option to change the name of the job.

Table 3: Model 306 Job Parameters (continued)

Parameter	Description
SORT ON THICKNESS	<p>Determines if the job is sorted by thickness.</p> <ul style="list-style-type: none">• Choices for this parameter are Yes or No. The default is No.• Display is tied to sort key setting and gate batching setting. If set to YES, additional thickness sorting parameters are displayed.
TMD POSITION	<p>Parameter is used to instruct operator where they should place the TMD when running this job.</p> <ul style="list-style-type: none">• Range is 1 to 14, default is 1. Closest to cut edge is 1.• This parameter is displayed when SORT ON THICKNESS = YES.
LEAD EDGE OFFSET	<p>Allows for initial thickness readings to be ignored when calculating the average thickness. This is due to the fact that the TMD will not provide accurate data until it settles.</p> <ul style="list-style-type: none">• Value is in tenths of an inch, as the readings are taken every ms.• Value can be set from 0 to 40. Default is 15.• This parameter is displayed when SORT ON THICKNESS = YES.
TRAIL EDGE OFFSET	<p>Allows for ending thickness readings to be ignored when calculating the average thickness. This is due to the fact that the TMD has a tendency to not provide accurate data at the end due to bouncing.</p> <ul style="list-style-type: none">• Value is in tenths of an inch, as the readings are taken every ms.• Value can be set from 0 to 40. Default is 2.• This parameter is displayed when SORT ON THICKNESS = YES.
THICKNESS MINIMUM	<p>This value represents the low end of the thickness range for primary mail.</p> <ul style="list-style-type: none">• Value can be set from 0 - 999, the default is 0.• This parameter is displayed when SORT ON THICKNESS = YES.

Table 3: Model 306 Job Parameters (continued)

Parameter	Description
THICKNESS MAXIMUM	<p>This value represents the high end of the thickness range for primary mail.</p> <ul style="list-style-type: none"> • Value can be set from 0 - 999, the default is 999. • This parameter is displayed when SORT ON THICKNESS = YES.
SORT ON LENGTH	<p>Determines if the job is sorted by length.</p> <ul style="list-style-type: none"> • Choices for this parameter are Yes or No. The default is No. • Display is tied to sort key setting and gate batching setting. If set to YES, additional length sorting parameters are displayed.
LENGTH MINIMUM	<p>This value represents the low end of the length measurement range for primary mail.</p> <ul style="list-style-type: none"> • Value can be set from 400 - 999, the default is 400. • This parameter is displayed when SORT ON LENGTH = YES.
LENGTH MAXIMUM	<p>This value represents the high end of the length measurement range for primary mail.</p> <ul style="list-style-type: none"> • Value can be set from 400 - 999, the default is 999. • This parameter is displayed when SORT ON LENGTH = YES.
SORT ON HEIGHT	<p>Determines if the job is sorted by height.</p> <ul style="list-style-type: none"> • Choices for this parameter are YES or NO. The default is NO. • Display is tied to sort key setting and gate batching setting. If set to YES, additional height sorting parameters are displayed.
WHEN HEIGHT BLOCKED	<p>Choices are PASS or FAIL, the default is FAIL.</p> <ul style="list-style-type: none"> • PASS indicates that the piece should go to primary pile if the piece blocks the height sensor. • FAIL indicates that the piece should go to secondary pile if the piece blocks the height sensor. • This parameter is displayed when SORT ON HEIGHT = YES.

Table 3: Model 306 Job Parameters (continued)

Parameter	Description
HEIGHT POSITION	<p>Parameter is used to instruct operator where they should place the height sensor when running this job.</p> <ul style="list-style-type: none"> • Range is 1-8, default is 1 (the shortest position is 1). • This parameter is displayed when SORT ON HEIGHT = YES.
MIXED MAIL	<ul style="list-style-type: none"> • Parameter is shown if the job has either sort on length or thickness set to YES. • Choices are YES or NO, default is YES. • When this parameter is set to NO, then any piece that is more than 1 ½ times the maximum average thickness setting OR 1 ½ times the maximum length setting will be counted as 2 pieces. This parameter is used to help provide more accurate counts.
PRIMARY SORT TO	<ul style="list-style-type: none"> • Parameter is shown if software key has sorting turned on. • Indicates which bin holds the primary sort. • Choices are LOWER and SIDE, default is LOWER.
GATE BATCHING	<ul style="list-style-type: none"> • Parameter is shown if software key has sorting turned on. • This parameter is mutually exclusive with the following parameters; SORT ON THICKNESS, SORT ON LENGTH, and SORT ON HEIGHT.
BATCH SIZE LOWER	<ul style="list-style-type: none"> • Parameter is shown if software key has batching turned on. • Parameter is used to set the batch size of the lower PCS. • Value can be set from 20 - 200 or DISABLED, the default is DISABLED.
BATCH SIZE SIDE	<ul style="list-style-type: none"> • Parameter is shown if software key has batching turned on. • Parameter is used to set the batch size of the side PCS. • Value can be set from 20 - 200 or DISABLED, the default is DISABLED.

Table 3: Model 306 Job Parameters (continued)

Parameter	Description
EXCEPTION THRESHOLD	<ul style="list-style-type: none"> • Parameter is shown if software key has sorting turned on. <p>This parameter will allow the supervisor to determine how the job should respond when it encounters an exception (error condition). Exceptions include: gap too small, double feeds, missing sort information, piece not arriving at counter sensor within expected time frame (jam window) and pieces still moving when jam is called. A value of 0 indicates to jam on every exception, 1 indicates to jam on 2 consecutive, etc.</p> <ul style="list-style-type: none"> • Value can be set from 0 - 255, default is 5.
STAMP ORIENTATION	<ul style="list-style-type: none"> • Parameter is always shown. • Parameter is used to instruct operator how they should place the mail in the feeder. The placement of mail in the feeder is important when running thickness sort or print jobs. • Choices are: ANY ORIENTATION, STAMP UP AND AWAY FROM OPERATOR, STAMP DOWN AND AWAY FROM OPERATOR, STAMP UP AND TOWARDS OPERATOR, STAMP UP AWAY FROM OPERATOR. Default is ANY ORIENTATION.
CUT DEPTH	<ul style="list-style-type: none"> • Parameter is always shown. • Parameter is used to instruct operator where they should place the cutter dial when running this job. • Choices are 0 - 8, default is 1. No cut is 0, deepest cut is 8.
PRINTER JOB	<ul style="list-style-type: none"> • Parameter is shown if software key has audit trail printer turned on. • Value of parameter can be NO PRINT or any of the audit trails that have been previously setup. The default is NO PRINT. • If set to any value other than NO PRINT, additional Printer Job parameters are displayed.

Table 3: Model 306 Job Parameters (continued)

Parameter	Description
DEPT. ID	Provides ability to spray a unique department ID on the mail. <ul style="list-style-type: none">• From 1 to 10 text characters can be set, default is D.I.• This parameter is displayed when PRINTER JOB = YES.
JOB TEXT	Provides ability to spray a unique job text string on the mail. <ul style="list-style-type: none">• From 1 to 10 text characters can be set, default is J.T.• This parameter is displayed when PRINTER JOB = YES.
POST DATE OFFSET	Provides the ability to postdate the mail. <ul style="list-style-type: none">• Values are from 0 - 9999, default is 0.• This parameter is displayed when PRINTER JOB = YES.
PRINT OFFSET	Provides the ability to delay spraying on the mail (relative to lead edge). <ul style="list-style-type: none">• Resolution is in ms, so each value is slightly more than 1/8 of an inch.• Values can be from 0 - 100, default is 0.• This parameter is displayed when PRINTER JOB = YES.
ENABLE DARK PRINT	Allows supervisor to spray dark or lightly on the mail. Obviously the dark spray will use more ink. <ul style="list-style-type: none">• Choices are YES or NO, default is NO.• This parameter is displayed when PRINTER JOB = YES.
PRINTER POSITION	Parameter is used to instruct operator where they should place the ink jet printer when running this job. <ul style="list-style-type: none">• Choices are from 0 to 8, default is 0. Closest to cut edge is 0.• This parameter is displayed when PRINTER JOB = YES.

Operator Menu

Selecting OPERATOR MENU on the Supervisor screen displays the following options:

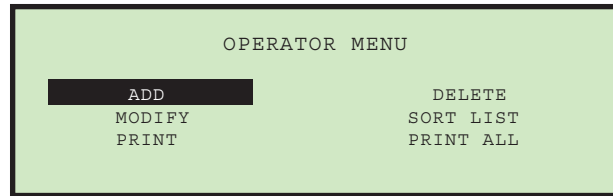

Figure 54: Operator Menu screen

- ADD – enter a new operator and setup the operator options.
- DELETE - select an operator from the operator list and delete the operator.
- MODIFY – select an existing operator from the operator list and modify the operator’s options.
- SORT LIST – alphabetically sort the operator list.
- PRINT – select an operator from the operator list and print all parameters associated with the selected operator.
- PRINT ALL - print the entire list of operators.

Add Operator

1. On the OPERATOR MENU screen (Figure 54), select ADD. The RENAME OPERATOR screen will appear (Figure 55).

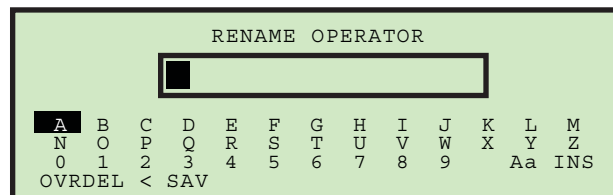

Figure 55: Rename Operator screen

2. Enter the operator’s name using the Arrow buttons to navigate through the onscreen keypad. Selecting SAV will create the new operator. Pushing the Cancel button on the keypad will end the operator creation process.

Once you have named the operator and selected SAV, the following screen appears.

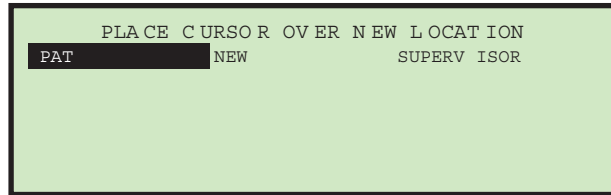

Figure 56: Place Cursor Over New Location screen

3. Place the cursor over an existing operator and press Enter to place the operator in the list. The new operator will be placed *after* the selected operator, and the MODIFY OPERATOR screen appears.

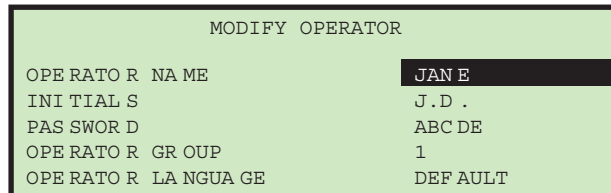

Figure 57: Modify Operator screen

4. Make any modification to the operator's parameters using the keypad buttons. Operator parameters include:
 - OPERATOR NAME - change the name of the operator.
 - INITIALS - change the initials of the operator. This allows the customer to spray a shorter audit trail string, if they want to include the operator's name.
 - PASSWORD - change the operator's password.
 - OPERATOR GROUP - provides a method to organize operators.
 - OPERATOR LANGUAGE - select the language used by the operator.
5. Press Enter to save the changes.

Changing an operator's initials

1. On the MODIFY OPERATOR screen, select INITIALS, and press the Enter key. The RENAME OPER INITIALS screen appears.

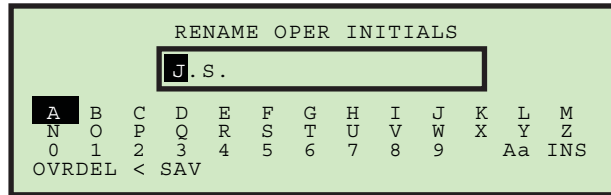

Figure 58: Rename Operator Initials screen

2. Use the Arrow keys to navigate to OVR and press Enter. This puts you in Over mode, and the cursor (black box) moves to the first letter.
3. Press Enter.
4. Use the Arrow keys to select the first initial of the name. Once selected, press Enter.
5. Use the Right arrow key to move the cursor to the last initial, and press Enter.
6. Use the Arrow keys to select the last initial of the name. Once selected, press Enter.
7. Press Cancel to exit out of Over mode.
8. Use the Arrow keys to navigate to SAV, and press Enter.

Delete Operator

The supervisor can select an operator from the operator list and delete them.

1. On the OPERATOR MENU screen (Figure 54), select DELETE. The SELECT OPER TO DELETE screen appears.

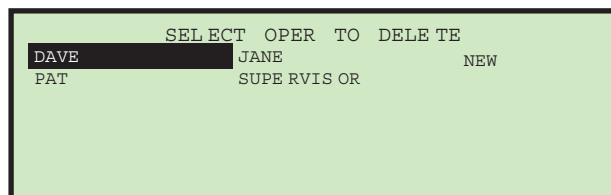

Figure 59: Select Operator to Delete screen

2. Use the Arrow keys to choose an operator, and press Enter to delete the operator. The operator will be deleted, and the display will return to the OPERATOR MENU screen.

Modify Operator

1. On the OPERATOR MENU screen (see Figure 54), select MODIFY. The SELECT OPERATOR screen will appear.

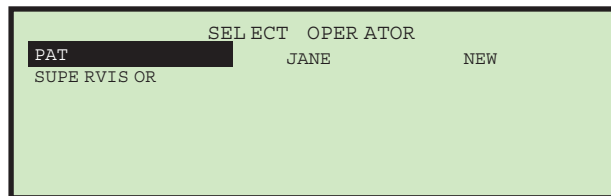

Figure 60: Select Operator screen

2. Use the Arrow keys to choose an operator, and press Enter to select the operator. The MODIFY OPERATOR screen appears.

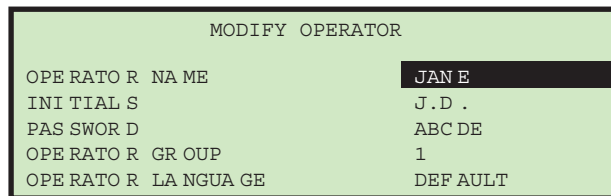

Figure 61: Modify Operator screen

3. Make any modification to the operator's parameters using the Arrow keys.
4. Press Enter to save the changes.

Sort List

1. On the OPERATOR MENU screen (Figure 54), select SORT LIST.
2. Selecting SORT LIST will alphabetically sort the operator list.

Print All or Individual Operator Parameters

Note: The optional report printer is required for printing parameters.

Operator information can be printed for an individual or all operators. The printout includes the name, password, group number and language. The printout choices are available from the OPERATOR MENU screen.

Selects an individual operator, and prints all parameters associated with them

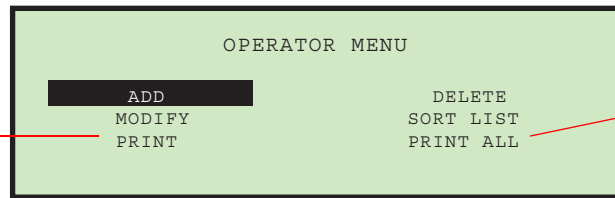

Prints the entire list of all operators

Figure 62: Operator Menu screen

The user must be logged in as supervisor to print out the report.

Note: If you want to print information for a specific operator, you will be presented with an additional screen where you can choose the operator.

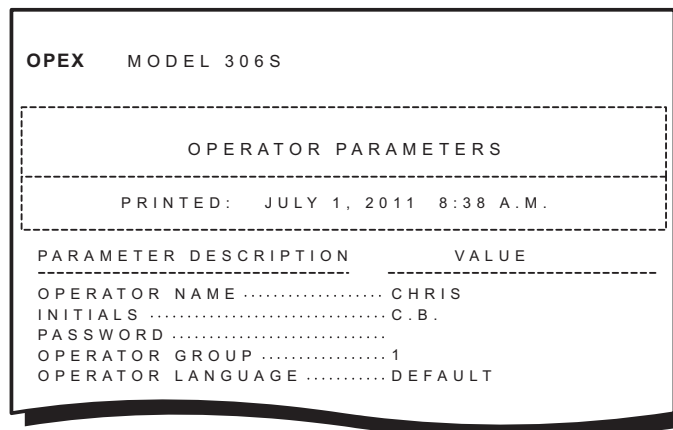

Figure 63: Example printout of Operator information

System Configuration Menu

Allows the Supervisor to view and edit the system configuration parameters. Selecting SYSTEM CONFIGURATION on the Supervisor Main Menu will display the following screen.

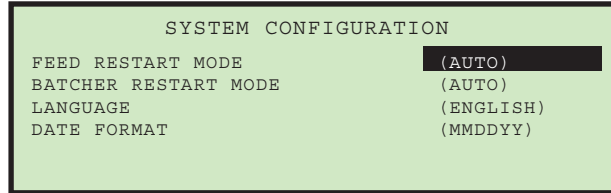

Figure 64: (Supervisor) System Configuration screen

The System Configuration screen offers the following options:

- FEED RESTART MODE - Default restarting mode of machine when a “feed empty” condition is detected. Choices are:
 - 0 = Auto (default). Auto mode requires the operator to place mail into the feed area and then it is automatically fed into the machine. Auto mode does not require the Enter key to be pressed.
 - 1 = Manual. Manual mode requires the operator to place mail into the feed area and then press Enter to restart the machine.
- BATCHER RESTART MODE - Default restarting mode of machine when a “batch full” condition is detected. Choices are:
 - 0 = Auto (default). Auto mode does not require the operator to press the Enter key to restart the machine.
 - 1 = Manual. Manual mode requires the operator to press Enter to restart the machine.
- LANGUAGE - Default language for the machine. Choices are:
 - 0 = English (default)
 - 1 = French
 - 2 = German
 - 3 = French-Canadian
 - 4 = Spanish
 - 5 = Portuguese
 - 6 = Italian
 - 7 = Dutch

- 8 = Danish
- 9 = Japanese

It should be noted that each operator can choose their own language and one of those selections is “default.” This means that changing this parameter could impact the language of some operators.

Note: *The time format displayed by the machine is tied to the language that is chosen. English will use a 12 hour clock, while all other languages will use a 24 hour clock.*

- DATE FORMAT - Default date/time format for the user interface and reports. Choices are:
 - 0 = MM/DD/YY (default)
 - 1 = DD/MM/YY
 - 2 = YYYY/MM/DD

Audit Trail Menu

Selecting AUDIT TRAIL MENU on the Supervisor Main Menu screen displays the AUDIT TRAIL SETUP screen as shown below.

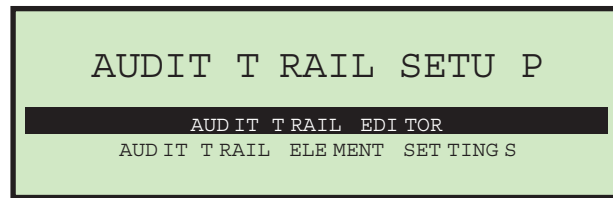

Figure 65: Audit Trail Setup screen

The optional audit trail spraying capabilities on the Model 306 are quite extensive. Managing the audit trails is done at the supervisor level. This menu selection provides the supervisor with two choices: Audit Trail Editor and Audit Trail Element Settings.

Audit trails define what can be sprayed in each job. A supervisor could use one audit trail for all of their jobs, share audit trails between a few jobs, or create an audit trail for each of their jobs. Audit trail elements are provided to help simplify the setup of audit trails.

Audit Trail Elements

Since both of the menu items have to do with audit trail elements, a summary of the audit trail elements should be shown before proceeding. Here is a list of the possible audit trail selections:

- AR - The text representing "Accounts Receivable" will be sprayed. Default in quotes.
- AT - The text representing "Accounting" will be sprayed. Default in quotes.
- BL - The text representing "Billing" will be sprayed. Default in quotes.
- CN - The text representing "Confidential" will be sprayed. Default in quotes.
- PB - The text for "Process By" will be sprayed. Default in quotes.
- PO - The text for "Processed On" will be sprayed. Default in quotes.
- T1 - User-assigned text will be sprayed. Default is "Text1".
- T2 - User-assigned text will be sprayed. Default is "Text2".
- T3 - User-assigned text will be sprayed. Default is "Text3".

- T4 - User-assigned text will be sprayed. Default is "Text4".
- T5 - User-assigned text will be sprayed. Default is "Text5".
- JN - The name of the job running during audit trail printing will be sprayed.
- DI - The department identification that is entered in the "DEPT. ID" field of the current job will be sprayed.
- JT - User-assigned text that is entered in the "JOB TEXT" field of the current job will be sprayed.
- ON - The current operator's name will be sprayed.
- OI - The current operator's initials will be sprayed.
- B1 - When selected, it will spray a Postnet barcode that contains the year, date, time in seconds and the envelope sequence number. See below for more details.

Note: *When selecting audit trail element B1, it must be positioned first in the string of audit trail elements in order for the Postnet barcode to print successfully. Placing audit trail element B1 anywhere else in the audit trail element string will result in failure of the barcode to print.*

- DT - The month day and year in the format that has been configured in the AUDIT TRAIL PRINTER PARAMETERS screen will be sprayed.
- TI - The hour minute and second in the format that has been configured in the AUDIT TRAIL PRINTER PARAMETERS screen will be sprayed.
- SN - A five-digit physical count of all envelopes that have been printed on will be sprayed. It is updated on every envelope sprayed. This value will start at zero and count up to 65,535 before wrapping to zero.
- < > - When selected, a character space is entered.
- NL - When selected, a new line is entered. Doing so will cause all following element selections to be sprayed on the next line.

Barcode 1 (B1) Details

A unique, 11-digit Postnet is sprayed based on the time/day that is set in the RTC (real-time clock) chip in the machine. The 11 digits in the barcode reflect the following information:

Table 4: Barcode digit information

1	Y - year represented by the least significant digit (limit of wrapping decade)
2-4	DOY - Day of year, a 3 digit number from 1-366
5-9	SOD - second of the day, a 5 digit number from 1-86,400 (24 X 60 X 60)
10-11	UU - Number representing piece processed within the last second, should range from 1-14 (2 digits needed because $50,000/3,600 = 13.8888$)

The above can be described as:

Total digits 11
 Position in barcode 1 234 56789 01
 Meaning Y DOY SOD UU

Here are some examples:

Barcode value	Decodes into:
20320780501	Year was 2012 (2), Date was February 1st (032), Time was 2:10:05 am (07805), 1st piece processed in the second (01)
23660003709	Year was 2012 (2), Date was December 31st (366), Time was 00:00:37 am (00037), 9th piece processed in the second (09)

The Model 306 software will optionally provide the supervisor with the ability to create and maintain a list of audit trails. A maximum of 100 audit trails are supported. The audit trails are created by selecting elements on lines. The lines can range from 1 to 4 lines, although the number of lines may be limited by one of the system configuration parameters.

Audit Trail Editor

On the Supervisor > Audit Trail Menu > Audit Trail Setup screen (see Figure 65), select AUDIT TRAIL EDITOR and press Enter. The CHANGE AUDIT TRAIL LIST screen appears as shown below.

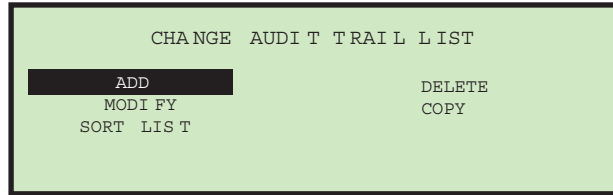

Figure 66: Change Audit Trail List screen

This menu will allow the supervisor to perform the following functions:

- ADD - add an audit trail - provides ability to choose location in list
- DELETE - delete an existing audit trail
- MODIFY - modify an existing audit trail
- COPY - an existing audit trail can be copied and used as a “template” for a new audit trail. It must have a new unique audit trail name. Provides ability to choose location in list.
- SORT LIST - this selection will sort all audit trails alphabetically

Audit Trail Element Settings

On the Supervisor > Audit Trail Menu > Audit Trail Setup screen (see Figure 65), select AUDIT TRAIL ELEMENT SETTINGS and press Enter. The AUDIT TRAIL ELEMENT SETTINGS screen appears as shown below.

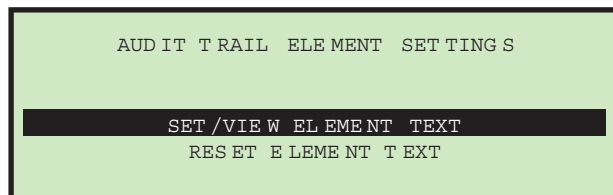

Figure 67: Audit Trail Element Settings screen

This selection will allow the supervisor to view and optionally modify some of the audit trail elements. The supervisor also has the option of resetting all element text. The audit trail element editor/viewer has some nice features such as:

- All elements have a leading and trailing character that shows what type of element they are.
 - Quotes (") indicate that they are associated with their own text.
 - Square brackets ([]) indicate they contain text that is associated with another parameter (examples: [job name], [operator name]).
 - Elements in brackets (<>) indicate that they will be filled in at run time (examples: <date>, <sequence number>).
- While all of the elements are shown, only the elements in quotes can be modified. The items in quotes appear at the top of the list. The following audit trail elements can be modified: AR, AT, BL, CN, PB, PO, T1, T2, T3, T4, T5
- When viewing the items, the two-character element shortcut will be shown on the left (example: AR) and more information about it will be shown on the right (example: "Accounts Receivable").
- The audit trail editor will provide the following editing tools:
 - INS - When selected, the user is allowed to place a newly-selected element between existing ones in the audit trail.
 - OVR - When selected, the user is allowed to place a newly-selected element over an existing one, effectively replacing it.
 - DEL - When selected, the entire audit trail is deleted.
 - < - When selected, an element is deleted.
 - SAV - When selected, the profile is saved.

Password Options

Selecting PASSWORD OPTIONS on the Supervisor Main Menu screen displays the PASSWORD OPTIONS screen as shown below.

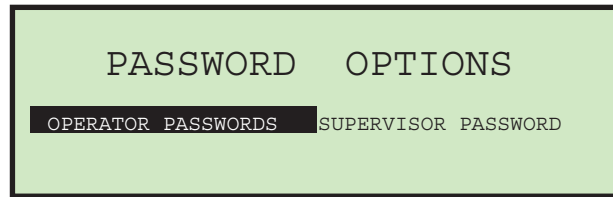

Figure 68: Password Options screen

Operator and Supervisor passwords can be globally enabled or disabled from this screen. The defaults for the passwords are set to enabled. If passwords are enabled, the operator or supervisor will only be prompted to enter a password if one already exists.

To disable operator passwords

1. Select PASSWORD OPTIONS on the Supervisor Main Menu screen.
2. Use the left/right arrows to select OPERATOR PASSWORDS and press Enter. The Operator Passwords screen appears as shown below.

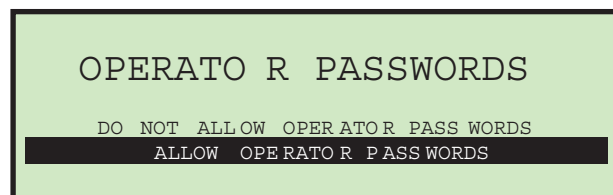

Figure 69: Operator Passwords screen

3. Use the arrows to select DO NOT ALLOW OPERATOR PASSWORDS, and press Enter.

Statistics

The operator and supervisor have the ability to view statistics.

Operator Statistics

The operator has the ability to display and optionally print their statistics on the optional stats reports printer. The operator can only view runs that were saved in their name.

More details of statistics can be found in “Supervisor Statistics” on page 60.

To view and/or print statistics

1. On the Run screen, use the Up/Down arrow buttons to select and highlight STATISTICS, then press Enter. The DISPLAY STATISTICS screen appears as shown below.

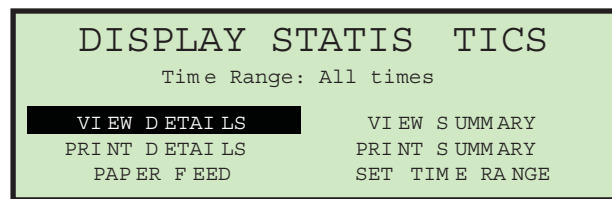

Figure 70: Display Statistics screen

The choices are:

- VIEW DETAILS - Pulls together all jobs run by this operator in the specified time range each in an individual view (in other words, if the operator ran 4 jobs, the data will be pulled together into 4 views).
- VIEW SUMMARY - Pulls together all jobs run by this operator in the specified time range in one view.
- PRINT DETAILS - provides a printout of the details described above. Requires the optional stats report printer.
- PRINT SUMMARY - provides a printout of the summary described above.
- PAPER FEED - allows you to advance paper in the reports printer (by pressing Enter), or exit out of paper feed mode (by pressing Cancel).
- SET TIME RANGE - allows operator to set specified date and time for pulling the above information together. More details in supervisor section.

- On the DISPLAY STATISTICS screen, use the arrow buttons to select and highlight SET TIME RANGE, and press Enter. The SELECT TIME RANGE screen appears (see Figure 71).



Figure 71: Select Time Range screen

- On the SELECT TIME RANGE screen, use the arrow buttons to select and highlight the desired time range, and press Enter.
- Using the navigation buttons, select and highlight the desired view or print function and press Enter.

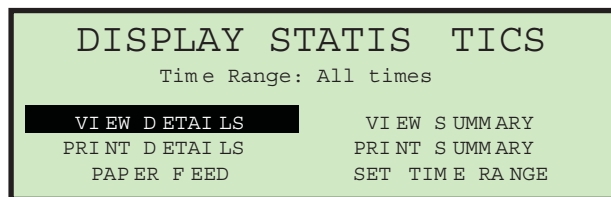

Figure 72: Display Statistics screen

Based on the selection made, the information is either displayed or printed. The following graphic shows an example of the VIEW DETAILS selection.

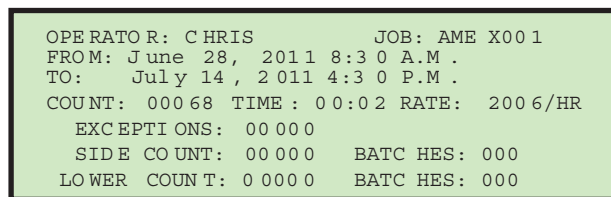

Figure 73: Statistics detail example

Supervisor Statistics

The Supervisor has the ability to view all operator statistics.

1. Log in as supervisor. The Supervisor Main Menu appears as shown below.

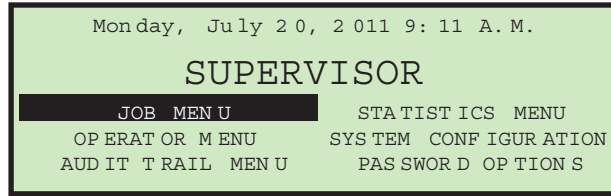

Figure 74: Supervisor Main Menu screen

2. Use the arrow buttons to highlight STATISTICS MENU, and press Enter. The Statistics menu appears as shown below.



Figure 75: Supervisor level - Statistics menu

The Supervisor Statistics menu offers the supervisor the ability to view and edit additional information.

Display Data

This screen allows you to view statistical data for all or specific operators.

1. In the Supervisor level - Statistics Menu (Figure 75), select DISPLAY DATA and press Enter. The DISPLAY STATISTICS screen appears as shown below.

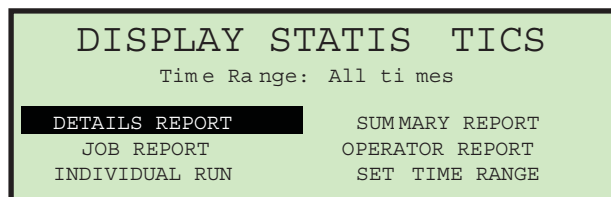

Figure 76: Supervisor level - Display Statistics menu

Display Statistics offers the following:

- DETAILS REPORT - displays statistics sorted by both job and operator.
- SUMMARY REPORT - displays statistics for all jobs.
- JOB REPORT - displays statistics for each job.
- OPERATOR REPORT - displays statistics for each operator.
- INDIVIDUAL RUN - displays individual statistics for each job run.
- SET TIME RANGE - You can also specify the time range of the statistics you want to view

Use the left/right arrow buttons to view each available report.

Print Data

In the Supervisor level - Statistics Menu (Figure 75), selecting PRINT DATA opens the PRINT STATISTICS window where you can choose from the following options:

- DETAILS REPORT - prints a Detailed Statistics Report.
- SUMMARY REPORT - prints a Summary Statistics Report.
- JOB REPORT - prints a Job Statistics Report.
- OPERATOR REPORT - prints an Operator Statistics Report.
- PAPER FEED - advances paper through the printer.
- SET TIME RANGE - select a time range for your printed report.

Reset Data

In the Supervisor level - Statistics Menu (Figure 75), selecting RESET DATA will clear all statistics. When this is selected, you are first presented with a warning screen.

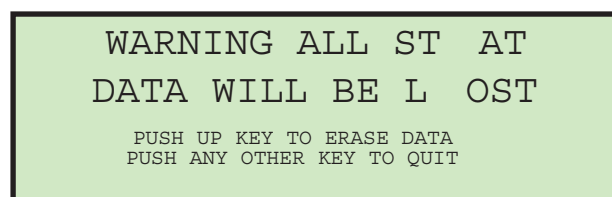

Figure 77: Reset Data warning screen

1. Press the Up key to erase and reset all statistical data, or press any other key to exit from this screen.

Set Clock

1. In the Supervisor level - Statistics Menu (Figure 75), selecting PRINT DATA opens the PRINT STATISTICS window where you can set the day, date and time of the system.



Figure 78: Set Clock screen

2. Use the left/right arrow buttons to select one of the clock's settings (example: Day, Month, Date, Year, etc.).
3. Use the up/down arrow buttons to set the clock.
4. When you are finished updating the clock, press Enter.

Troubleshooting

When a machine stops for a reason other than the operator canceling out of a job, the LCD will display an error message, as described below:

Table 5: Model 306 Error messages

Error Message	Description
PLEASE CHECK MAIL FEEDER	Once the Feed Empty sensor goes blocked, software starts a timer for FEED EMPTY TIMEOUT (machine parameter) period of time. If this timer times out and no mail was placed in the feed area, then this message is displayed. At the same time another timer is started for FEED NO ACTIVITY TIMEOUT (machine parameter) in seconds. While waiting for this timer to time out, the software will continue to look at the Feed Empty sensor to show mail was placed into the feeder. If this second timer times out, then the machine will turn off and the message is removed from the screen.

Table 5: Model 306 Error messages (continued)

Error Message	Description
PLEASE CHECK FEED EXIT	If the feeder clutch is engaged, the system is running in continuous mode and the Feed Exit sensor is detected to be blocked longer than the MAX SENSOR BLOCKED TIME (machine parameter) then this jam will be called. This jam is called during machine startup, when all sensors are checked to be clear before the motor is turned on. If the Feed Exit sensor is found to be blocked, then the motors are not started and instead this jam is called.
THICKNESS DETECT OVER RANGE	Before motors are turned on to run mail, the thickness detect module is checked for proper operation. If the TMD reading is above TMD MAXIMUM NULL READING (machine parameter), then this jam will be called.
THICKNESS DETECT UNDER RANGE	Before motors are turned on to run mail, the thickness detect module is checked for proper operation. If the TMD reading is below TMD MINIMUM NULL READING (machine parameter), then this jam will be called.
PIECE TOO SHORT OR MISSED TMD	After the thickness data is captured using the TMD, software will run some filtering algorithms on the collected data. If there is no data left after filtering, then this jam will be called.
REMOVE PIECE HEIGHT SENSOR AREA	This jam is called during machine startup, when all sensors are checked to be clear before the motor is turned on. If the Env. Height sensor is found to be blocked, then the motors are not started and instead this jam is called. Additionally, this jam is called when the machine is running and the height sensor is blocked when the Feed Exit and Cutter Path sensors are unblocked for MAX SENSOR BLOCKED TIME (machine parameter).

Table 5: Model 306 Error messages (continued)

Error Message	Description
PLEASE CLEAR THE CUTTER AREA	<p>This jam is called during machine startup, when all sensors are checked to be clear before the motor is turned on. If the Cutter Path sensor is found to be blocked, then the motors are not started and instead this jam is called.</p> <p>This jam is called if the Cutter Path sensor is detected to be blocked longer than the MAX SENSOR BLOCKED TIME (machine parameter) when the machine is processing mail.</p>
PLEASE CLEAR THE COUNTER AREA	<p>This jam is called during machine startup, when all sensors are checked to be clear before the motor is turned on. If the COUNTER PATH is found to be blocked, then the motors are not started and instead this jam is called.</p> <p>This jam is called if the COUNTER PATH is detected to be blocked longer than MAX SENSOR BLOCKED TIME (machine parameter) when the machine is processing mail.</p>
PLEASE CLEAR LENGTH SENSOR AREA	<p>This jam is called during machine startup, when all sensors are checked to be clear before the motor is turned on. If the Length Path sensor is found to be blocked, then the motors are not started and instead this jam is called.</p> <p>This jam is also called if the Length Path sensor is detected to be blocked longer than the MAX SENSOR BLOCKED TIME (machine parameter) when the machine is processing mail.</p>
UNEXPECTED ENVELOPE AT COUNTER	<p>This jam is called if a lead edge is detected at the COUNTER PATH, yet that lead edge was not seen at the Cutter Path sensor. This jam will only be called when the currently running job is performing any sorting activity (length, height and/or thickness).</p>

Table 5: Model 306 Error messages (continued)

Error Message	Description
PLEASE CLEAR THE SIDE BIN PATH	This jam is called during machine startup, when all sensors are checked to be clear before the motor is turned on. This jam is called if the Side Bin Path sensor is detected to be blocked longer than the MAX SENSOR BLOCKED TIME (machine parameter).
AUDIT TRAIL PRINTER NOT DETECTED	Prior to starting motors, the software will send a message over to the printer. If the printer does not communicate back, then this jam will be called.
AUDIT TRAIL PRINTER CARTRIDGE DOOR OPEN	Prior to starting motors, the software will check to see if the cartridge door is open. If the interlock indicates the printer cartridge door is open, then this jam will be called.
AUDIT TRAIL PRINTER CARTRIDGE FAULT	Prior to starting motors, the software will check to see if the cartridge is present. If the IMTECH software indicates there is an issue with the cartridge, then this jam will be called.
AUDIT TRAIL PRINTER COMM FAULT	Prior to starting motors, the software will send a message over to the printer. If the printer response indicates a problem, then this jam will be called. During printing jobs, the printer also responds to print messages with status. If a problem is detected at this time, then this jam will be called.
AUDIT TRAIL PRINTER FAULT DETECTED	Prior to starting motors, the software will send a message over to the printer. If the printer attempts to communicate back and there is some form of communication issue, then this jam will be called.

Routine Maintenance

It is important that you keep your machine clean and in good working order. This will prolong the overall life of the machine and result in longer periods of “up” time. Failure to perform daily cleaning tasks may result in the voiding of your service contract. Therefore, it is vitally important that you perform the following tasks at least once per day:

Clean the Model 306

1. Use a vacuum cleaner with a crevice tool to vacuum dust and debris from all exposed components of the machine.
2. Clean the exterior surfaces and panels with a multi-purpose type cleaner.
 - Use denatured alcohol on areas with stains, if necessary.
 - Any non-flammable commercially available cleaning solution may be used to clean the machine. When cleaning the OPEX Model 306, **DO NOT USE** aerosol cleaners or compressed air because of the flammable nature of many of these products. There is a risk of equipment malfunction and/or injury associated with the use of aerosol cleaners on OPEX equipment prior to the operation of equipment.
 - When cleaning glass and plastic surfaces, use detergent-based cleaners such as Fantastic™ or Formula 409™. Detergent-based cleaners are recommended, because they do not cause component degradation.



WARNING: A cloth soaked with cleaning detergent or similar material should never be used to clean an object such as a belt or roller when the belt or roller is being driven by the system. Use of a cloth or similar material on moving mechanisms can result in personal injury. If a belt, pulley or similar part needs to be cleaned, it should be cleaned while stationary.

- Wipe dust and debris from the sensors. Debris build-up can cause jams. Accumulations of dirt and debris can cover sensors, preventing them from working effectively. This will hinder machine performance.
3. Before carefully removing any chips or paper jammed in the cutter, unplug the machine.
 4. Empty the cutter trash bin. The mill cutter chips are collected in a trash bin located in front of the operator's feet. The bin should be checked and emptied on a regular basis. Failure to empty the trash bin will result in chips "haystacking" up toward the cutter mechanism, preventing additional chips from falling into the trash. This may lead to the cutter itself being jammed.

If this happens, empty the trash bin. Then clear the cutter so that no chips remain, using a pencil or similar tool to push down chips which have collected between the cutter and surrounding frame.

Replacing Report Printer Paper

The printer will automatically detect if it's out of paper. A "No paper in printer" message will be displayed. The steps below describe how to replace printer paper in the Model 306. The printer is accessed from the side of the machine.

1. Open the printer door. The printer drawer is hinged on the bottom. The drawer will open and swing down on its hinge.
2. Check to see if the entire old roll of paper has fed through the printhead.
 - If all of the paper is out of the printhead, go to step 4..
 - If there is any paper remaining in the printhead, go to step 3..
3. Remove the remaining paper:
 - a. Do not attempt to pull the paper out of the printhead or try to feed the paper through the printer rollers manually.
 - b. Tear or cut the paper as shown below and lift the old roll out of the printer.

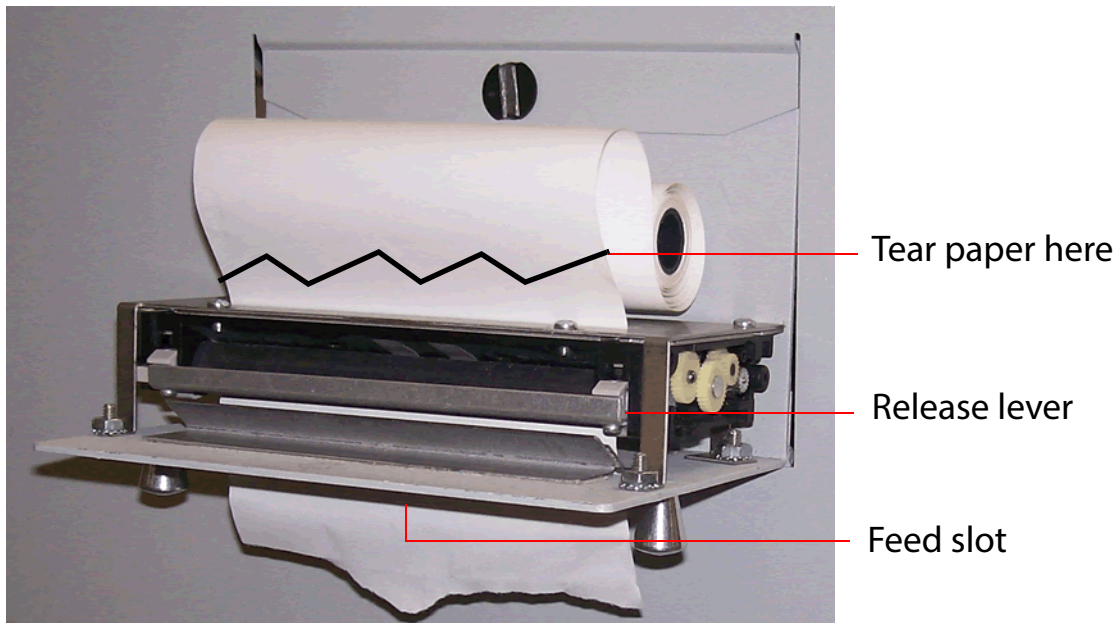

Figure 79: Paper removal

- c. Press the release lever down and pull the remaining paper out of the printer.
- d. Once the paper has been removed from the printer, lift the release lever up until it clicks in place.

4. Place a new roll of paper on the metal shaft and install the roll in the printer so that the paper will feed from the top of the roll (see Figure 79). The paper will automatically feed into the printer.
5. If you want to advance the paper further, access the SUPERVISOR > STATISTICS MENU > PRINT DATA > PAPER FEED screen, and press and hold Enter until the report printer has fed several inches of paper through the printhead.
6. Release the Enter button and close the printer door.

Cleaning the Audit trail printer cartridge head

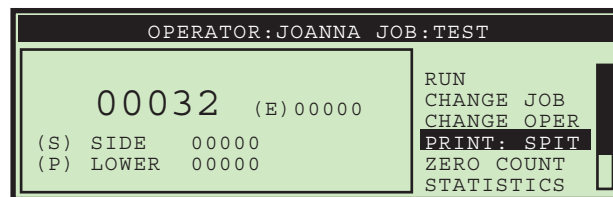

Figure 80: Run screen with PRINT = ON

In jobs that have printing enabled (as in Figure 80), the PRINT selection will provide the operator with the ability to clean the print cartridge head. This is accomplished by allowing the user to spit ink out of the cartridge, which will help to get the ink flowing.

1. On the Run screen, use the Arrow buttons to select PRINT, and press Enter.
2. Press the Enter key a few times until “PRINT: SPIT” appears with instructions, as in Figure 81.

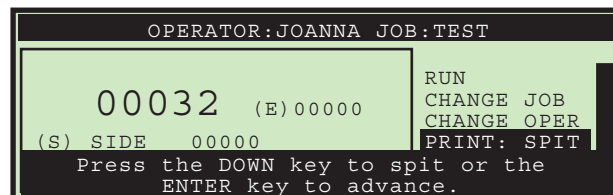

Figure 81: Run screen with PRINT = SPIT

3. Insert a scrap piece of paper underneath the printer, and press the Down arrow key. You may have to do this a few times if the printer is clogged.
4. When you are pleased with the results, press the Cancel button.

Specifications

Machine Dimensions	Length: 47.75" (121.285 cm) Depth: 21" (53.34 cm) Height: 58" (147.32 cm) Weight: 245 lbs
Power	100 VAC, 50/60Hz (Japan) 115 VAC, 60Hz, 8.5 Amps (US) 230 VAC, 50Hz, 5.5 Amps (Euro)
BTU	BTU/hour (100 VAC) 3338 BTU/hour (115 VAC) 4317 BTU/hour (230 VAC)
Speed	Up to 40,000/hour
Envelope Sizes	Lengths up to 11.5" (29.21 cm) may be sorted. Lengths up to 13.5" (34.29 cm) may be opened.
Thickness	Up to 0.50" (1.27 cm)
Depth of Cut	Nine settings: from 0.01" (0.03 cm) at envelope edge up to 0.125" (0.32 cm) (depth settings 1-8), also no cut (setting 0)
Feeder Hopper Capacity	Up to 400 envelopes
Stand & Waste bin	Included
306 Options	Batch Counter (counts down to preset size and stops or pauses), Hi-Speed Inkjet printer (Prints a variety of custom strings, date & time, sequential numbering & ID Tag barcodes), Stats Report Printer (Produces a variety of statistics reports for monitoring machine performance)
306s Options	Sorter (thickness, height, length) with Output Bin, Sorter (thickness, height, length) with 90 Degree Powered Conveyor
Power Source	The socket outlet must be installed near the equipment and must be easily accessible at all times.

Power Disconnect	The electrical disconnect is the AC power cord at the back of the machine. Unplug the cord to remove all electrical power.
-------------------------	--

FCC information / informations FCC

This device complies with part 15 of the FCC Rules. Operation is subject to the following two conditions: (1) This device may not cause harmful interference, and (2) this device must accept any interference received, including interference that may cause undesired operation.

Cet appareil est conforme à la partie 15 des règles de la FCC. Son fonctionnement est soumis aux deux conditions suivantes: (1) ce dispositif ne doit pas causer d'interférences nuisibles, et (2) cet appareil doit accepter toute interférence reçue, y compris les interférences qui peuvent provoquer un fonctionnement indésirable.

Industry Canada information / Industrie Canada l'information

This Class A digital apparatus complies with Canadian ICES-003.

Cet appareil numérique de la classe A est conforme à la norme NMB-003 du Canada.

